

Ergebnis: **300** (316.0)

Wertung: 300                      Serien: 37 41 39 44 32 32 41 34

Zähler: 2 8 12 8 7 2 1 0 0 0 0

Innenzehner: 0

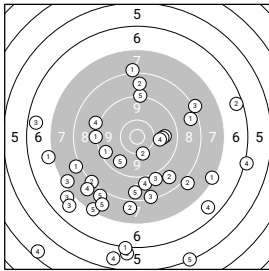

Wertung

**Wertung**

<b>Serie 1:</b>	7.1 [4.11] ←	8.2 [5.60] ↙	7.4 [6.62] ↙	6.7 [7.66] ↘	9.2 [8.90] ↑
<b>Serie 2:</b>	9.5 [3.54] ←	6.5 [4.67] →	9.8 [6.08] →	9.1 [7.18] ←	8.6 [8.28] ↓
<b>Serie 3:</b>	8.5 [4.36] →	9.9 [5.99] →	6.6 [7.40] ←	8.9 [8.55] ↓	8.0 [9.65] ↙
<b>Serie 4:</b>	8.1 [5.23] ↑	8.7 [6.26] ↑	9.0 [7.36] ↘	10.0 [8.25] →	9.7 [9.22] ↙
<b>Serie 5:</b>	8.0 [4.06] ←	7.9 [5.18] ↓	7.0 [6.26] ↙	4.5 [7.57] ↙	6.0 [8.61] ↓
<b>Serie 6:</b>	6.2 [4.66] ↓	8.8 [6.08] ↘	6.8 [7.38] ↙	5.7 [8.73] ↓	7.3 [9.87] ↙
<b>Serie 7:</b>	9.2 [4.18] ←	10.2 [5.49] ↓	8.3 [6.80] ↓	7.9 [7.95] ↙	7.7 [9.14] ↙
<b>Serie 8:</b>	7.3 [4.29] ↘	8.0 [5.49] ↘	8.2 [6.41] →	6.2 [7.75] →	5.3 [8.87] ↘

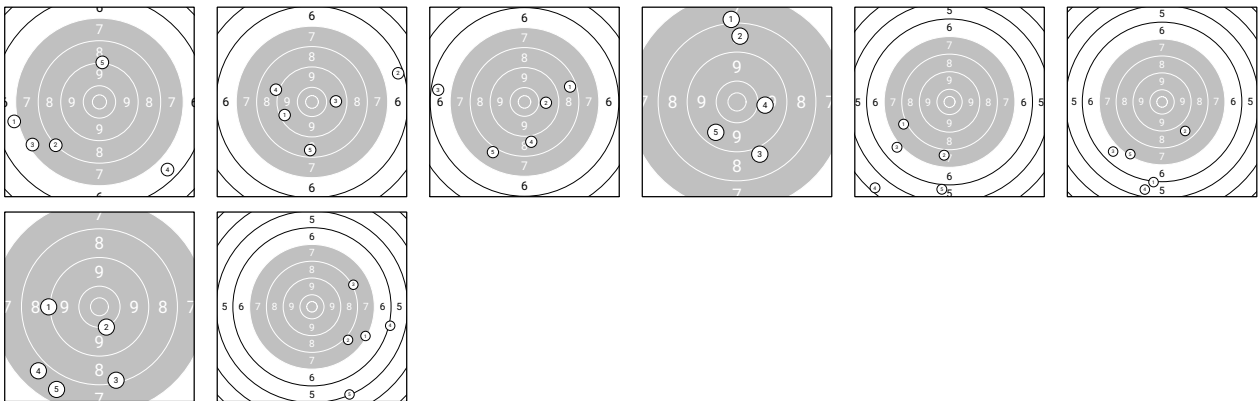

Ergebnis: **325** (342.0)

Wertung: 325                      Serien: 39 43 46 38 39 39 40 41

Zähler: 6 12 11 7 2 0 2 0 0 0 0

Innenzehner: 5

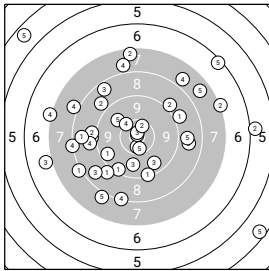

Wertung

**Wertung**

<b>Serie 1:</b>	10.5* [2.88] ↓	9.0 [4.05] ←	9.7 [5.30] ↘	7.2 [6.50] ←	4.5 [7.35] ↘
<b>Serie 2:</b>	9.5 [2.70] ←	9.1 [4.27] ←	7.0 [5.63] ←	9.0 [7.01] ←	9.9 [8.14] ↖
<b>Serie 3:</b>	9.0 [2.97] →	7.5 [3.94] ↑	10.9* [5.50] ↑	10.2 [6.42] ↖	10.5* [7.91] ↓
<b>Serie 4:</b>	9.3 [2.96] ↓	7.2 [4.28] →	10.8* [5.31] ↑	8.2 [6.42] ←	4.6 [7.56] ↖
<b>Serie 5:</b>	9.4 [3.02] ↓	6.0 [4.62] →	9.8 [5.74] ↓	7.9 [6.74] ↗	8.0 [7.74] ↓
<b>Serie 6:</b>	8.1 [3.91] ←	9.0 [5.48] ↗	8.8 [6.69] →	8.3 [7.74] ↓	6.4 [8.95] ↗
<b>Serie 7:</b>	8.6 [3.26] ←	8.9 [4.88] ↖	8.5 [6.16] ↖	8.0 [7.28] ←	8.9 [8.53] →
<b>Serie 8:</b>	9.0 [4.02] ↘	10.5* [5.41] ↗	8.7 [6.54] ↘	7.9 [8.04] ↑	7.7 [8.80] ↗

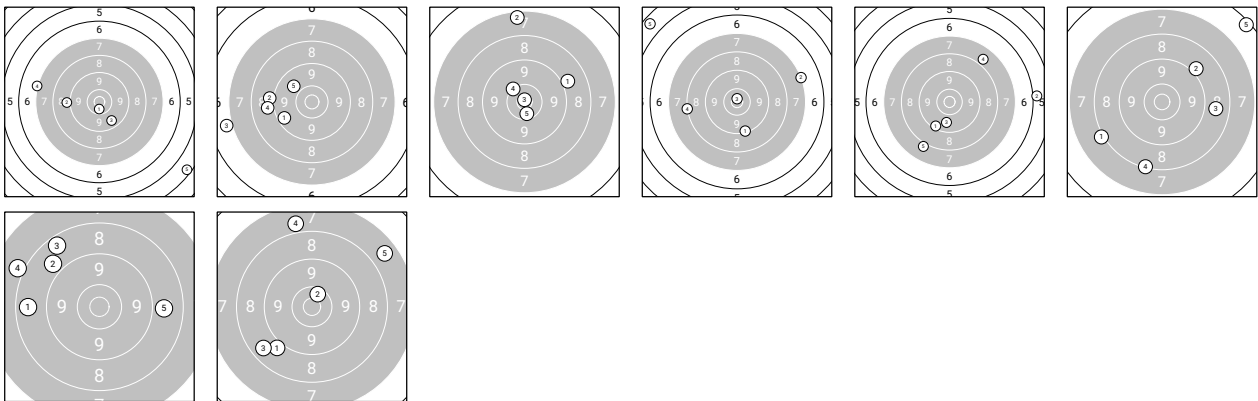

Ergebnis: **307** (325.3)

Wertung: 307                      Serien: 39 37 41 36 40 30 39 45

Zähler: 3 11 10 4 10 2 0 0 0 0 0

Innenzehner: 0

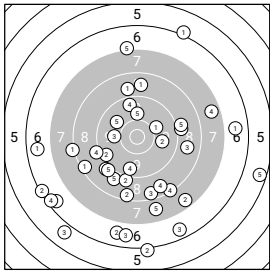

Wertung

**Wertung**

<b>Serie 1:</b>	8.7 [3.85] ↑	9.4 [5.02] ↙	6.6 [6.12] ↙	9.1 [7.25] →	7.8 [8.32] ↓
<b>Serie 2:</b>	6.1 [3.84] ↗	7.6 [5.37] ↘	5.9 [6.38] ↙	9.6 [7.29] ↑	10.0 [8.40] ↑
<b>Serie 3:</b>	8.9 [3.20] ↑	8.4 [4.54] ↓	8.5 [5.57] ↓	9.1 [6.59] ↙	8.9 [7.94] ↙
<b>Serie 4:</b>	6.7 [3.97] ↖	6.8 [5.27] ↓	9.0 [6.44] ↙	6.4 [7.39] ↙	9.9 [8.68] ↖
<b>Serie 5:</b>	8.4 [3.40] ↙	9.0 [4.93] ↓	6.6 [5.85] ↓	8.3 [6.97] ↓	9.0 [8.09] →
<b>Serie 6:</b>	6.8 [3.75] →	6.1 [5.10] ↓	6.8 [6.04] ↓	7.6 [7.14] →	5.5 [8.11] →
<b>Serie 7:</b>	10.1 [4.15] →	6.3 [5.36] ↙	8.8 [6.21] →	8.6 [7.22] ↓	7.2 [8.32] ↑
<b>Serie 8:</b>	8.2 [3.86] ↖	9.9 [5.02] →	10.0 [5.93] ↖	9.6 [6.84] ↓	9.1 [7.83] ↙

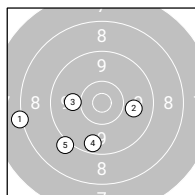
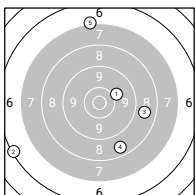
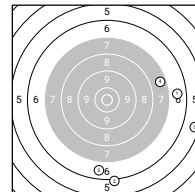
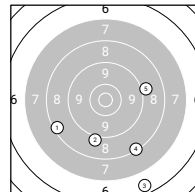
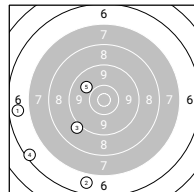
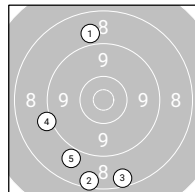
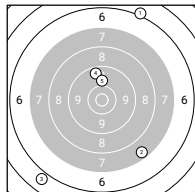
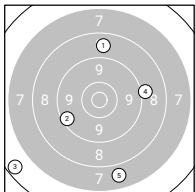

Ergebnis: **290** (309.1)

Wertung: 290                      Serien: 36 35 34 30 40 41 37 37

Zähler: 1 11 6 13 4 2 2 0 0 0 1

Innenzehner: 1

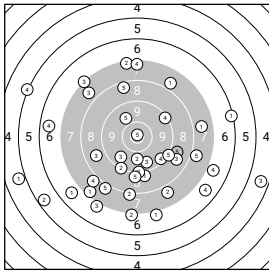

Wertung

**Wertung**

<b>Serie 1:</b>	7.5 [3.73] ↙	7.2 [5.29] ↓	4.6 [7.27] ➔	9.4 [8.69] ↘	9.9 [9.86] ↗
<b>Serie 2:</b>	4.9 [2.85] ↙	7.4 [5.16] ↑	7.8 [6.68] ↗	9.3 [7.91] ↗	8.0 [9.53] ➔
<b>Serie 3:</b>	6.8 [3.87] ↙	5.5 [5.64] ↙	9.7 [7.15] ↘	6.8 [8.50] ↘	8.0 [9.79] ↙
<b>Serie 4:</b>	7.9 [3.06] ↗	8.2 [6.05] ↓	8.8 [7.68] ↙	7.9 [8.88] ↙	0.0 <sup>+</sup> AST,OOT ➔
<b>Serie 5:</b>	9.0 [3.41] ↓	9.9 [4.84] ↓	8.8 [6.13] ➔	6.7 [7.59] ↙	8.5 [8.76] ↑
<b>Serie 6:</b>	6.3 [3.61] ➔	9.3 [5.52] ↓	9.7 [6.94] ↙	7.0 [8.14] ➔	10.9* [9.05] ↑
<b>Serie 7:</b>	7.1 [3.27] ↓	9.3 [6.71] ↙	7.1 [7.83] ↙	5.2 [8.88] ↙	9.2 [9.67] ➔
<b>Serie 8:</b>	7.8 [3.27] ➔	7.9 [4.79] ↘	7.3 [6.13] ↗	7.5 [7.65] ↑	9.0 [8.69] ↓

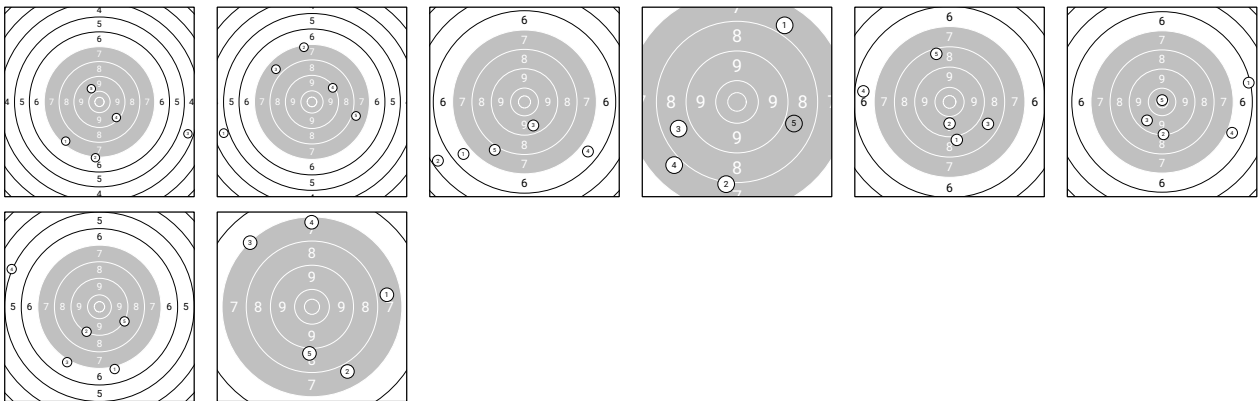

**Fußnoten-Legende:**

- AST - Treffer wurde nach Ende der Schießzeit abgegeben
- OOT - Treffer wurde außerhalb der Schießzeit abgegeben



Ergebnis: **319** (332.8)

Wertung: 319                      Serien: 41 34 41 37 41 43 38 44

Zähler: 8 6 14 5 4 2 1 0 0 0 0

Innenzehner: 1

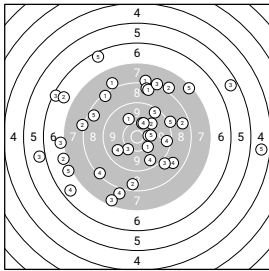

Wertung

**Wertung**

<b>Serie 1:</b>	8.1 [4.07] ↑	10.0 [5.41] ↗	10.2 [7.00] ↘	9.4 [7.73] →	4.7 [8.61] →
<b>Serie 2:</b>	8.5 [5.24] ↑	8.6 [7.04] →	5.6 [7.92] ↗	6.6 [8.58] ↘	7.1 [9.10] ↙
<b>Serie 3:</b>	10.2 [4.61] ↘	8.0 [5.87] ↗	5.9 [6.68] ↙	9.6 [8.02] ↘	9.4 [9.08] ↗
<b>Serie 4:</b>	8.5 [5.39] ↑	7.1 [6.36] ↙	7.1 [7.77] ↙	8.0 [8.68] ↘	7.4 [9.74] ↗
<b>Serie 5:</b>	10.4* [4.97] →	10.2 [6.27] ↗	7.5 [7.55] ↘	8.3 [8.20] ↘	6.5 [9.20] ↙
<b>Serie 6:</b>	10.0 [5.34] ↘	8.1 [6.83] ↙	6.4 [7.73] ↙	10.2 [8.44] ↗	9.1 [9.55] ↗
<b>Serie 7:</b>	8.0 [5.06] ↙	6.8 [6.65] ↙	8.1 [7.29] ↗	8.7 [8.62] ↘	8.5 [9.49] ↙
<b>Serie 8:</b>	8.3 [4.74] ↙	8.6 [6.20] ↘	9.0 [7.20] ↘	9.8 [8.69] ↘	10.3 [9.51] →

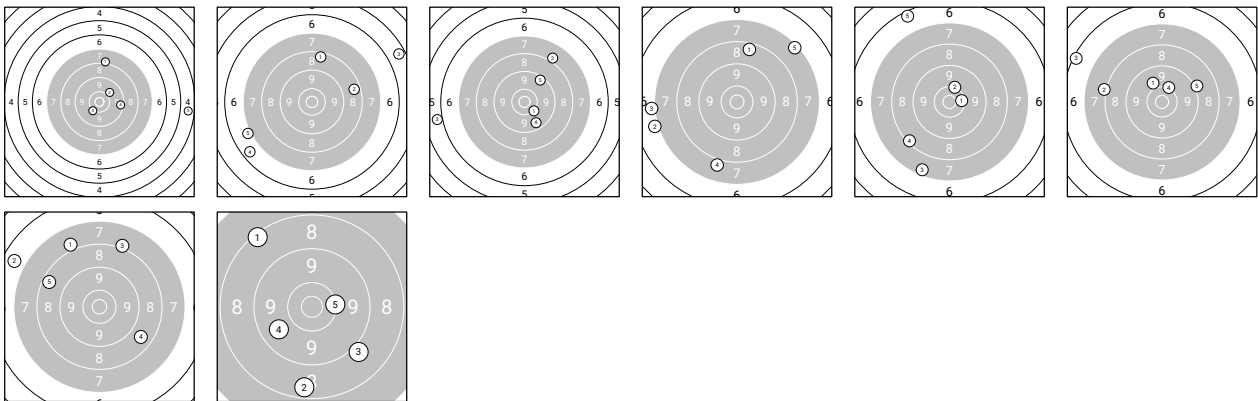

Ergebnis: **370** (386.6)  
 Wertung: 370                      Serien: 43 47 44 46 49 47 49 45  
 Zähler: 16 18 6 0 0 0 0 0 0 0  
 Innenzehner: 4

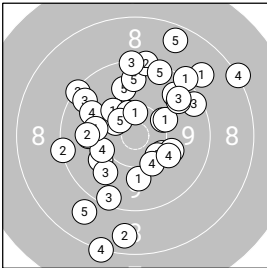

Wertung

**Wertung**

<b>Serie 1:</b>	10.0 [4.44] ↘	8.6 [6.05] ↓	9.4 [7.07] ↓	8.2 [8.02] ↓	8.9 [8.82] ↓
<b>Serie 2:</b>	10.0 [5.01] ↓	9.3 [6.19] ↙	9.5 [7.27] ↙	10.4* [8.26] ↙	9.9 [9.08] ←
<b>Serie 3:</b>	8.9 [4.36] ↗	10.2 [5.61] ↘	9.9 [6.70] ↘	9.6 [7.55] ↗	8.6 [8.41] ↗
<b>Serie 4:</b>	9.2 [4.01] ↗	10.2 [5.35] ↗	9.4 [6.46] ↗	9.8 [7.55] ↙	9.8 [8.67] ↗
<b>Serie 5:</b>	10.2 [4.55] ↗	9.7 [5.97] ↗	10.0 [7.24] ↗	10.1 [8.35] ↙	10.3 [9.22] ↘
<b>Serie 6:</b>	10.0 [0.00] ←	9.3 [0.00] ←	9.6 [0.00] ↗	10.2 <sub>NAM</sub> [0.00] ↓	9.7 <sub>NAM</sub> [0.00] ↑
<b>Serie 7:</b>	10.2 [4.08] ↙	9.9 [5.34] ←	10.4* [6.54] ↗	10.1 [7.71] ↘	10.5* [8.70] ↙
<b>Serie 8:</b>	10.4* [4.37] ↑	9.3 [5.62] ↑	9.3 [6.65] ↑	8.2 [7.77] ↗	9.4 [8.59] ↗

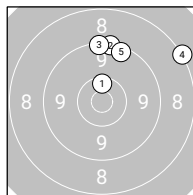
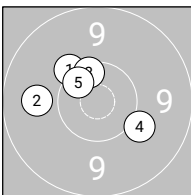
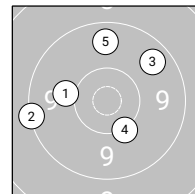
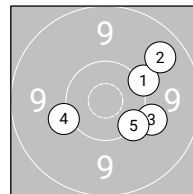
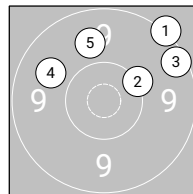
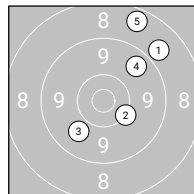
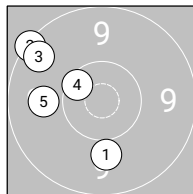
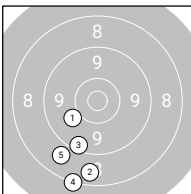

**Fußnoten-Legende:**

NAM - nicht anerkannte Waffenstörung



Ergebnis: **298** (314.8)

Wertung: 298                      Serien: 40 37 41 39 38 31 36 36

Zähler: 1 9 11 12 2 3 2 0 0 0 0

Innenzehner: 0

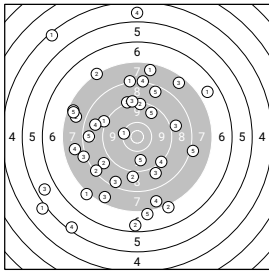

Wertung

**Wertung**

<b>Serie 1:</b>	10.3 [3.22] ←	7.7 [4.50] ←	8.9 [5.71] ↓	8.2 [7.04] ↑	7.1 [8.48] ↓
<b>Serie 2:</b>	9.1 [3.48] ←	6.6 [4.74] ↓	7.5 [5.88] ↓	7.6 [6.87] ↓	8.5 [7.93] ←
<b>Serie 3:</b>	7.2 [3.71] ↙	9.0 [5.11] ↓	7.6 [6.20] ↗	9.2 [7.52] ↘	9.2 [8.39] ↑
<b>Serie 4:</b>	6.8 [3.90] ↗	9.3 [5.67] ↑	9.0 [6.67] →	7.5 [7.92] ↖	8.5 [9.08] ↗
<b>Serie 5:</b>	8.2 [3.28] ↑	8.8 [4.51] ↖	8.1 [5.72] ←	5.4 [6.81] ↘	9.8 [8.47] ↓
<b>Serie 6:</b>	4.4 [3.49] ↘	7.1 [4.72] ↓	5.7 [5.70] ←	8.8 [7.10] ←	7.6 [8.55] ←
<b>Serie 7:</b>	7.6 [3.69] ↑	8.3 [4.65] ↖	8.5 [6.36] ↓	4.8 [7.26] ↑	9.6 [8.96] ↗
<b>Serie 8:</b>	5.0 [3.49] ↖	7.2 [4.84] ↘	9.2 [6.14] ↑	7.8 [7.61] ←	8.1 [9.13] →

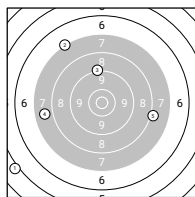
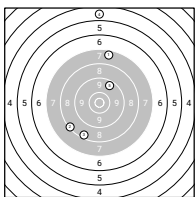
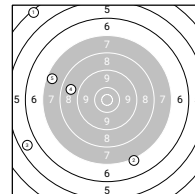
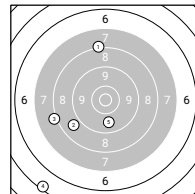
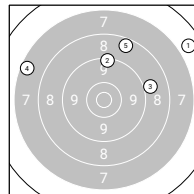
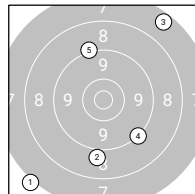
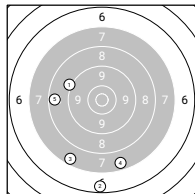
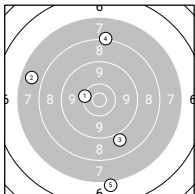

Ergebnis: **309** (324.3)

Wertung: 309                      Serien: 42 40 36 32 41 40 41 37

Zähler: 4 11 10 10 1 0 2 2 0 0 0

Innenzehner: 2

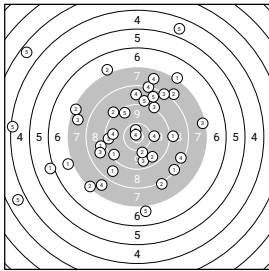

Wertung

**Wertung**

<b>Serie 1:</b>	9.4 [4.58] ↙	7.4 [5.80] ↙	9.6 [6.82] ↓	8.7 [7.73] ↑	9.0 [8.72] ↑
<b>Serie 2:</b>	7.2 [4.24] ↗	10.1 [5.57] ↓	10.6* [6.55] ↑	10.8* [7.92] ↖	3.6 [8.95] ↖
<b>Serie 3:</b>	6.0 [4.42] ↙	8.0 [5.48] ↗	8.3 [6.39] ↗	10.1 [7.31] →	4.3 [9.03] ↖
<b>Serie 4:</b>	7.0 [4.78] ↙	7.1 [6.42] ↖	7.4 [7.69] →	8.2 [8.37] ↑	3.8 [8.99] ↙
<b>Serie 5:</b>	9.0 [3.92] →	9.1 [5.67] ↖	7.7 [6.40] ↖	7.7 [7.28] ↑	9.5 [8.58] ↖
<b>Serie 6:</b>	8.7 [3.54] ↙	8.1 [4.96] ↓	9.1 [5.93] ↗	7.8 [7.06] ↙	8.7 [8.08] ↗
<b>Serie 7:</b>	9.0 [7.00] ↖	7.3 [7.55] ↙	9.4 [8.28] ↖	9.7 [8.87] ↖	7.0 [9.34] ↓
<b>Serie 8:</b>	8.3 [3.98] ↘	9.6 [5.16] ↘	8.8 [6.89] ↖	8.4 [7.77] ↘	4.8 [8.81] ↗

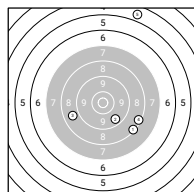
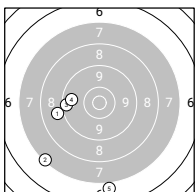
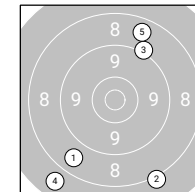
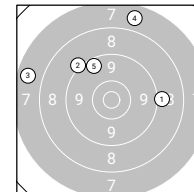
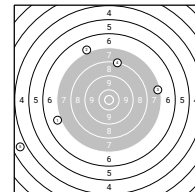
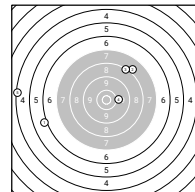
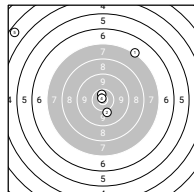
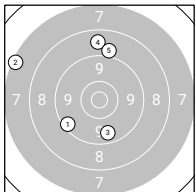

Ergebnis: **339** (355.5)

Wertung: 339                      Serien: 44 41 40 45 42 41 44 42

Zähler: 6 20 4 8 1 1 0 0 0 0 0

Innenzehner: 2

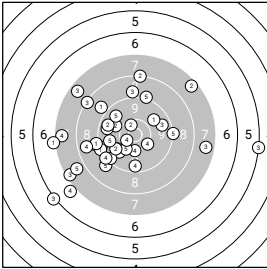

Wertung

**Wertung**

<b>Serie 1:</b>	9.9 [4.87] ↙	10.0 [6.01] ↖	9.6 [7.19] ➔	7.0 [8.33] ↘	9.0 [9.21] ↘
<b>Serie 2:</b>	9.3 [5.18] ↙	9.1 [6.41] ↙	5.2 [7.64] ➔	9.5 [8.66] ↓	9.1 [9.60] ↗
<b>Serie 3:</b>	9.2 [4.59] ↙	8.2 [6.22] ↑	7.6 [7.37] ➔	7.6 [8.76] ↙	9.6 [9.76] ↙
<b>Serie 4:</b>	9.1 [4.14] ↙	9.9 [5.42] ↘	7.4 [6.87] ↙	10.2 [8.01] ↓	10.2 [9.15] ↘
<b>Serie 5:</b>	9.4 [4.06] ↙	9.8 [5.27] ↘	9.0 [6.45] ↑	8.6 [7.47] ↙	7.8 [8.55] ↙
<b>Serie 6:</b>	7.2 [4.57] ↙	9.6 [5.83] ↙	6.2 [6.84] ↙	10.5* [8.26] ↙	9.7 [9.20] ↙
<b>Serie 7:</b>	8.9 [3.81] ↘	10.5* [5.10] ↗	8.3 [6.20] ↙	9.2 [7.19] ↙	9.2 [8.04] ➔
<b>Serie 8:</b>	9.9 [3.34] ↗	7.5 [4.73] ↗	7.6 [6.17] ↙	10.2 [7.39] ➔	9.7 [8.33] ↘

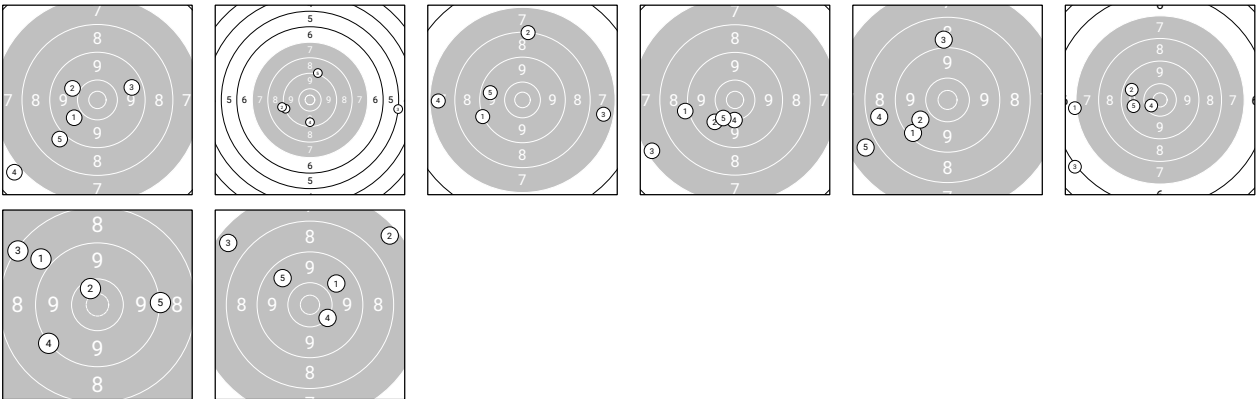

Ergebnis: **313** (329.8)

Wertung: 313                      Serien: 38 45 40 38 38 35 39 40

Zähler: 3 12 9 13 2 0 0 0 0 1

Innenzehner: 1

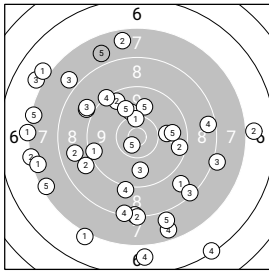

Wertung

**Wertung**

<b>Serie 1:</b>	8.8 [3.84] ↘	8.7 [4.95] ←	9.9 [6.42] →	6.3 [7.24] ↘	7.4 [8.27] ←
<b>Serie 2:</b>	9.0 [3.67] ←	9.5 [4.61] →	10.1 [5.96] ↑	7.6 [7.12] ↘	10.6* [8.00] ↘
<b>Serie 3:</b>	9.4 [3.59] ←	9.5 [4.71] ↘	7.0 [5.88] ←	8.3 [7.16] ↓	7.3 [7.92] ←
<b>Serie 4:</b>	7.1 [5.33] ↘	8.2 [6.70] ↓	8.3 [7.66] ↘	8.3 [8.49] ↓	7.9 [9.18] ↘
<b>Serie 5:</b>	7.0 [4.86] ←	7.3 [5.88] ←	9.8 [6.62] ↓	6.8 [7.64] ↓	9.9 [8.46] ↑
<b>Serie 6:</b>	10.3 [5.67] ↑	7.0 [7.55] →	9.0 [8.65] ←	9.1 [9.74] ↓	0.0+ <sup>AST</sup> OOT ↑
<b>Serie 7:</b>	7.2 [4.51] ←	7.6 [5.83] ↑	8.1 [6.70] →	8.5 [7.62] →	9.7 [8.66] →
<b>Serie 8:</b>	7.4 [3.39] ←	8.9 [4.56] ←	7.9 [5.35] ↘	9.2 [6.17] ↘	9.9 [7.05] ↘

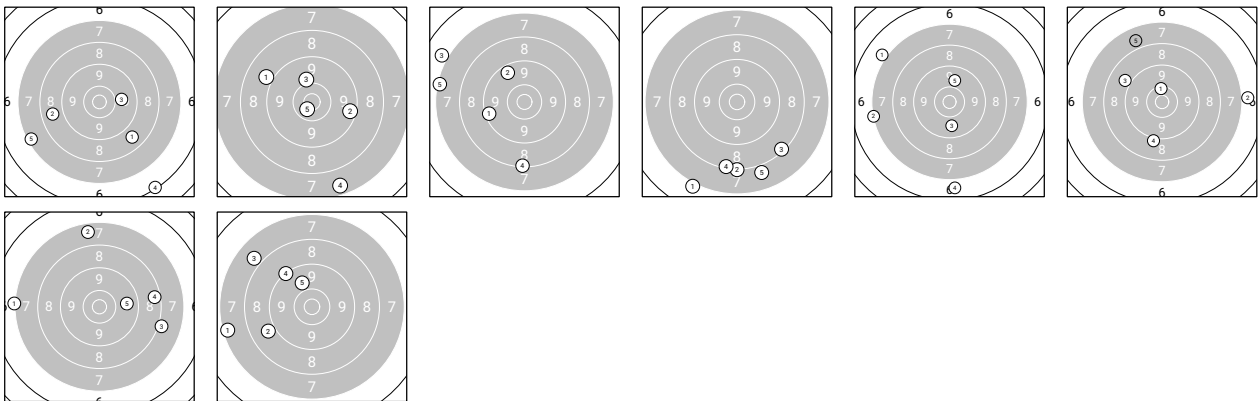

**Fußnoten-Legende:**

- AST - Treffer wurde nach Ende der Schießzeit abgegeben
- OOT - Treffer wurde außerhalb der Schießzeit abgegeben



Ergebnis: **313** (332.8)

Wertung: 313                      Serien: 39 33 43 40 40 35 43 40

Zähler: 2 15 8 8 4 2 1 0 0 0 0

Innenzehner: 2

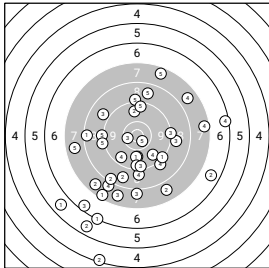

Wertung

**Wertung**

<b>Serie 1:</b>	8.4 [4.34] ←	4.3 [5.59] ↓	10.4* [6.47] ←	9.0 [7.40] ↓	8.7 [8.29] ↑
<b>Serie 2:</b>	5.7 [4.25] ↗	5.7 [5.58] ↓	6.5 [6.41] ↘	7.5 [7.57] →	10.6* [8.59] ↘
<b>Serie 3:</b>	9.9 [4.01] ↓	9.7 [5.33] ↑	8.9 [6.65] →	8.0 [7.46] ↘	9.1 [8.32] ↑
<b>Serie 4:</b>	7.4 [5.31] ↘	8.7 [6.43] ↓	7.7 [7.75] ↓	9.1 [8.87] ↘	9.2 [9.80] ←
<b>Serie 5:</b>	9.9 [4.55] ↓	7.8 [5.47] ↘	8.0 [6.61] ↓	9.7 [7.98] ↘	7.7 [9.17] ←
<b>Serie 6:</b>	6.3 [4.86] ↘	6.7 [5.93] ↘	9.2 [7.11] →	7.7 [8.30] ↗	7.6 [9.76] ↗
<b>Serie 7:</b>	9.3 [4.60] ↘	8.4 [5.76] ↘	8.9 [6.86] ↖	9.6 [8.13] ↘	9.1 [9.54] ←
<b>Serie 8:</b>	9.4 [4.59] ↓	7.7 [5.75] ↘	9.4 [6.73] ↓	6.4 [7.71] →	9.5 [8.52] ↑

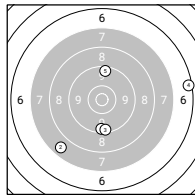
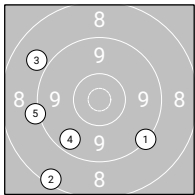
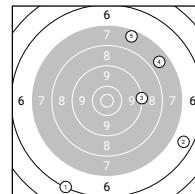
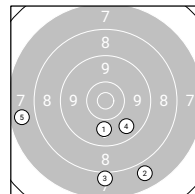
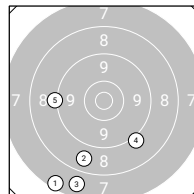
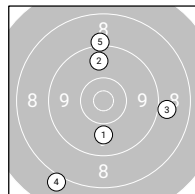
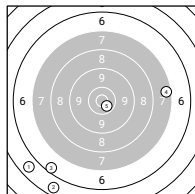
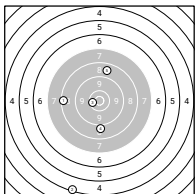

Ergebnis: **301** (317.7)

Wertung: 301                      Serien: 35 44 44 36 37 35 32 38

Zähler: 4 11 5 10 5 3 1 1 0 0 0

Innenzehner: 0

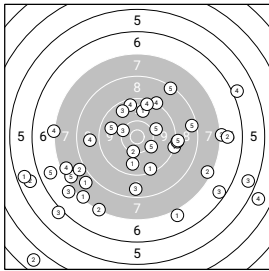

Wertung

**Wertung**

<b>Serie 1:</b>	9.8 [4.43] ↑	5.8 [5.90] ↙	6.1 [7.28] ↘	8.8 [8.02] ←	7.5 [8.67] ↙
<b>Serie 2:</b>	9.7 [3.85] ↓	10.3 [5.18] ↓	10.3 [6.30] ↙	9.5 [7.41] ↑	6.7 [8.12] ↙
<b>Serie 3:</b>	9.2 [4.91] →	9.1 [5.92] →	7.2 [6.78] →	9.2 [7.84] ↑	10.2 [8.95] ↘
<b>Serie 4:</b>	5.6 [4.11] ↙	6.9 [5.47] →	8.6 [6.45] ↓	9.4 [7.14] ↑	8.5 [8.06] →
<b>Serie 5:</b>	7.3 [4.28] ↘	7.3 [6.09] ↘	7.0 [7.12] ↙	7.5 [8.38] ↙	9.7 [9.11] ↙
<b>Serie 6:</b>	9.4 [4.65] ↓	7.4 [5.80] ↘	5.6 [6.89] →	6.0 [7.88] →	8.3 [9.42] ↑
<b>Serie 7:</b>	7.0 <sub>NAM</sub> [0.00] ↓	3.7 [0.59] ↙	6.5 [1.87] ↘	7.2 [2.67] ←	9.1 [3.32] →
<b>Serie 8:</b>	7.9 [4.36] ↘	8.0 [5.63] ↙	9.6 [6.64] ↘	4.8 [7.57] →	10.0 [8.39] →

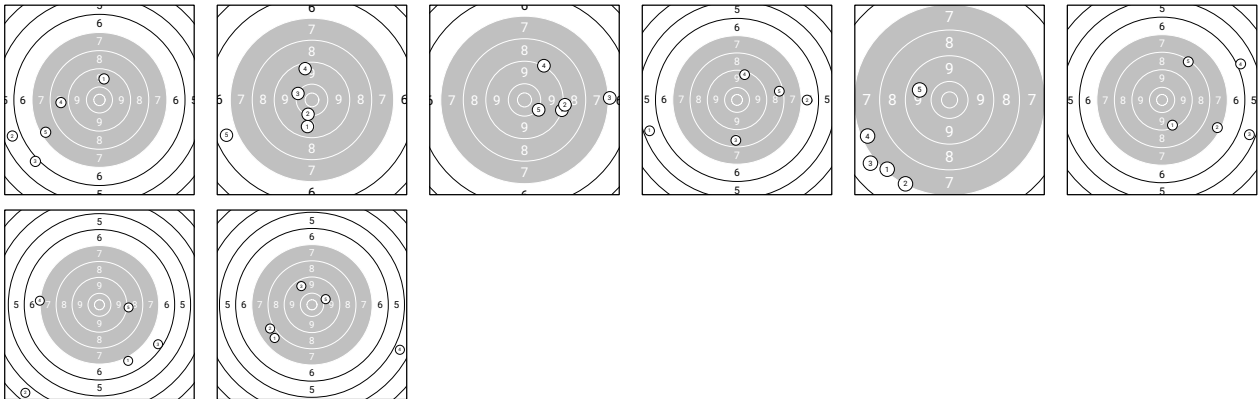

**Fußnoten-Legende:**

**NAM** - nicht anerkannte Waffenstörung



Ergebnis: **310** (326.7)

Wertung: 310                      Serien: 42 35 40 42 38 35 39 39

Zähler: 4 8 14 6 4 4 0 0 0 0 0

Innenzehner: 0

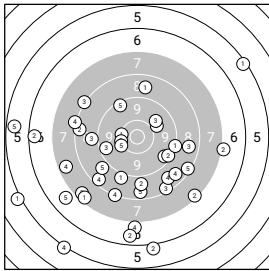

Wertung

**Wertung**

<b>Serie 1:</b>	9.5 [4.99] ↘	8.4 [6.40] ←	9.5 [7.51] ←	7.6 [8.25] ↙	9.4 [9.62] ↗
<b>Serie 2:</b>	8.8 [5.63] ↑	9.4 [6.97] ↘	8.4 [8.00] ↘	5.2 [8.69] ↙	5.6 [9.42] ←
<b>Serie 3:</b>	9.3 [5.25] →	6.5 [6.46] ←	9.0 [7.55] ←	8.5 [8.77] ↙	8.6 [9.58] ↓
<b>Serie 4:</b>	10.3 [5.16] ←	8.9 [6.28] ↓	10.2 [7.03] ←	8.7 [7.82] ↘	6.9 [9.18] ↙
<b>Serie 5:</b>	9.0 [4.54] ↘	7.2 [6.09] →	7.5 [6.91] ←	7.0 [7.91] ↓	8.9 [9.16] ↙
<b>Serie 6:</b>	5.1 [4.52] ↙	6.0 [6.35] ↓	8.7 [7.06] →	8.6 [7.86] ↘	8.4 [8.72] ↘
<b>Serie 7:</b>	7.5 [5.74] ↙	6.6 [6.76] ↓	8.2 [7.85] ↗	8.2 [8.43] ←	10.0 [9.00] →
<b>Serie 8:</b>	5.4 [5.50] ↗	7.4 [7.11] ↘	9.9 [8.06] ↗	8.2 [8.62] ↘	10.2 [9.22] ←

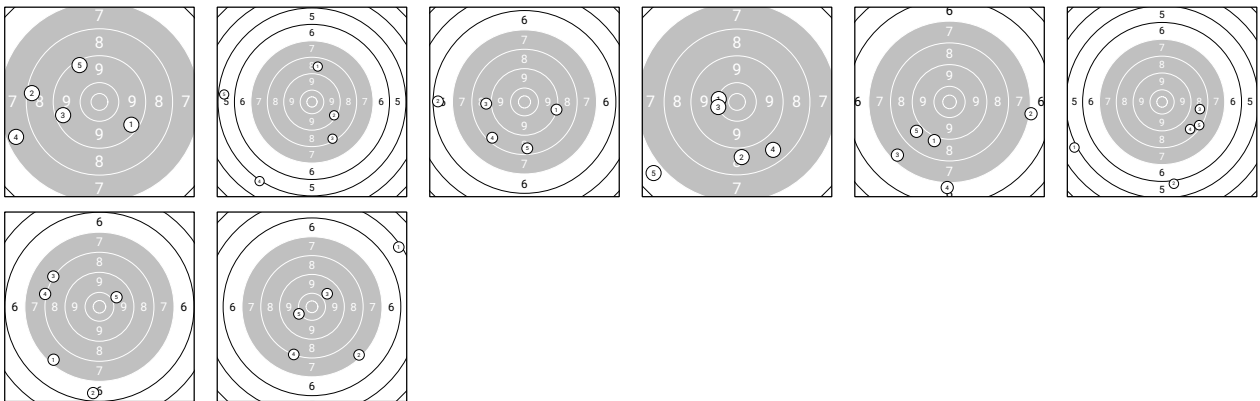

Ergebnis: **263** (284.1)

Wertung: 263                      Serien: 34 32 23 40 35 41 24 34

Zähler: 3 7 7 5 9 3 1 1 1 1 1

Innenzehner: 0

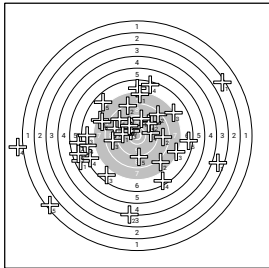

Wertung

**Wertung**

<b>Serie 1:</b>	7.5 [3.46] ←	4.3 [5.16] ↓	6.7 [7.32] ↙	8.9 [8.28] ←	9.2 [9.53] ↓
<b>Serie 2:</b>	2.4 [2.73] →	10.0 [4.09] ↘	7.4 [5.89] →	6.6 [7.04] ↘	7.8 [8.50] ←
<b>Serie 3:</b>	3.7 [5.56] →	8.0 [6.27] ↘	6.9 [7.34] ↑	6.5 [7.98] ←	
<b>Serie 4:</b>	10.1 [3.66] ↘	8.3 [4.83] ↑	8.8 [6.00] ←	6.7 [6.98] ←	8.9 [8.45] ↘
<b>Serie 5:</b>	5.7 [3.27] ←	5.9 [4.71] ←	10.3 [6.02] ↘	9.8 [7.31] →	6.9 [8.85] ↘
<b>Serie 6:</b>	9.7 [2.85] ←	9.3 [4.20] →	5.7 [5.80] ←	9.9 [6.91] ↘	9.5 [8.28] →
<b>Serie 7:</b>	9.5 [3.82] ↑	8.4 [4.66] →	6.7 [5.44] ←	0.0 [7.34] ←	1.5 [8.16] ←
<b>Serie 8:</b>	7.4 [3.36] ↑	8.8 [4.63] →	7.3 [6.32] →	6.5 [7.17] ↑	6.6 [8.67] →

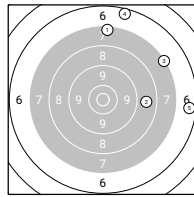
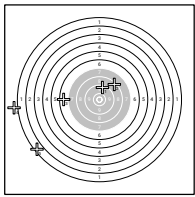
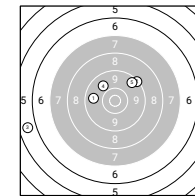
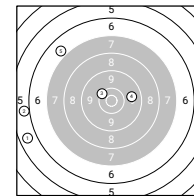
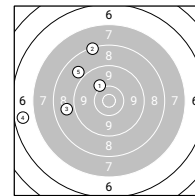
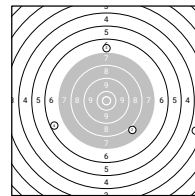
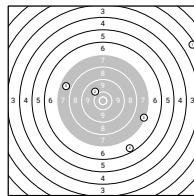
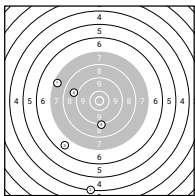

Ergebnis: **315** (335.2)

Wertung: 315                      Serien: 41 45 43 33 39 34 42 38

Zähler: 4 9 12 10 3 2 0 0 0 0 0

Innenzehner: 3

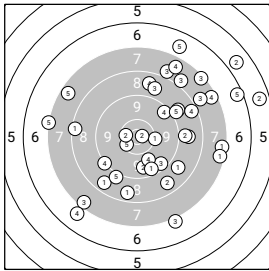

Wertung

**Wertung**

<b>Serie 1:</b>	8.6 [2.67] ↘	8.8 [4.49] →	7.5 [6.12] ↘	9.4 [7.26] ↗	9.1 [8.31] ↘
<b>Serie 2:</b>	10.2 [2.62] →	10.7* [4.11] →	9.5 [4.99] ↘	8.7 [6.39] ↑	8.9 [7.91] ↗
<b>Serie 3:</b>	8.4 [2.33] ←	9.7 [4.29] ↓	7.1 [5.45] ↘	9.9 [6.97] ↘	10.4* [7.99] ←
<b>Serie 4:</b>	8.8 [3.59] ↘	5.6 [6.08] →	7.4 [6.92] ↗	7.5 [7.61] ↗	6.5 [8.36] →
<b>Serie 5:</b>	9.5 [3.13] ↘	9.0 [4.33] →	7.9 [5.39] ↗	8.5 [6.25] ↗	6.8 [7.55] ↑
<b>Serie 6:</b>	7.4 [5.14] →	5.8 [5.90] ↗	8.0 [6.79] ↑	7.7 [8.02] ↑	7.2 [8.81] ←
<b>Serie 7:</b>	8.6 [2.70] ↓	10.5* [3.88] ←	8.0 [5.63] ↗	9.2 [6.57] ↘	7.6 [7.81] ↘
<b>Serie 8:</b>	7.4 [2.95] →	8.7 [5.08] ↘	8.8 [6.83] ↑	6.9 [7.90] ↘	9.0 [8.73] ↗

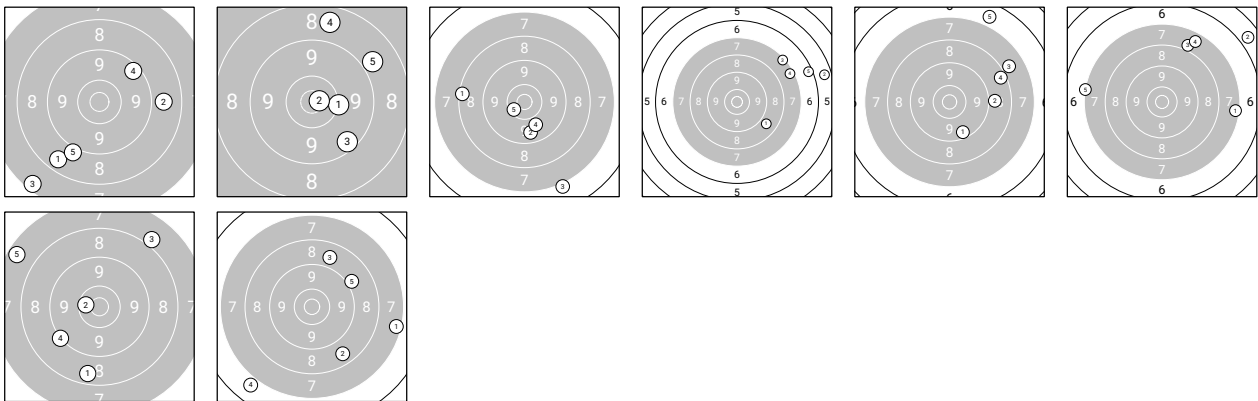

Ergebnis: **321** (339.4)

Wertung: 321                      Serien: 40 40 45 44 40 35 37 40

Zähler: 4 8 15 12 0 1 0 0 0 0 0

Innenzehner: 1

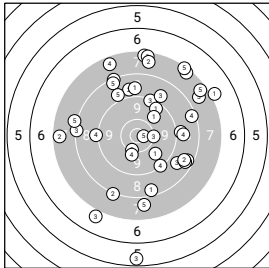

Wertung

**Wertung**

<b>Serie 1:</b>	8.5 [5.52] ↓	8.9 [6.37] ↑	8.3 [7.10] ←	9.0 [7.74] →	7.9 [8.32] ↓
<b>Serie 2:</b>	8.9 [6.33] ↑	8.3 [6.98] ↖	9.3 [7.63] ↗	8.4 [8.25] →	7.7 [8.78] ↗
<b>Serie 3:</b>	9.5 [5.39] ↗	10.3 [6.12] ↓	7.0 [6.85] ↓	9.1 [7.45] ←	10.7* [8.03] →
<b>Serie 4:</b>	9.8 [5.46] ↗	8.2 [6.14] ↓	10.2 [6.79] →	9.3 [7.37] ↘	8.1 [7.99] ←
<b>Serie 5:</b>	8.5 [6.29] ↘	7.5 [7.12] ←	8.8 [7.83] ↘	10.1 [8.49] ↓	7.5 [9.11] ↗
<b>Serie 6:</b>	7.1 [6.19] ↗	7.4 [6.91] ↑	7.4 [7.56] ↑	7.4 [8.19] ↗	7.3 [8.81] ↗
<b>Serie 7:</b>	8.6 [5.35] ↘	8.6 [6.07] ↘	5.5 [6.90] ↓	8.9 [7.52] →	8.4 [8.17] ↖
<b>Serie 8:</b>	9.8 [5.93] ↘	7.7 [6.66] ↑	8.9 [7.31] ↗	7.6 [7.95] ↖	9.0 [8.49] ↖

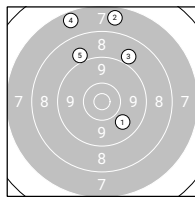
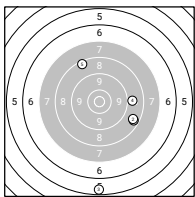
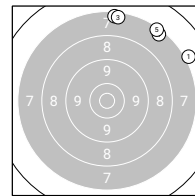
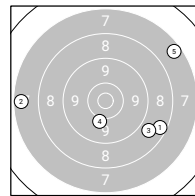
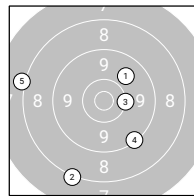
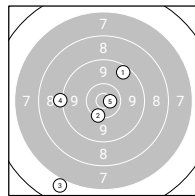
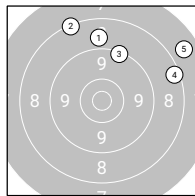
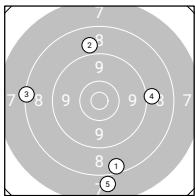

Ergebnis: **339** (356.4)

Wertung: 339                      Serien: 44 41 41 46 47 33 42 45

Zähler: 10 11 14 4 0 0 0 0 0 0 1

Innenzehner: 5

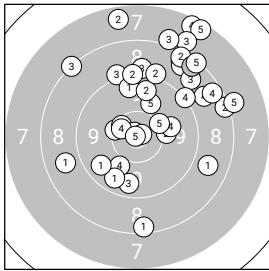

Wertung

**Wertung**

<b>Serie 1:</b>	10.3 [4.87] ←	7.6 [6.03] ↑	9.0 [7.14] ↑	10.0 [7.97] ↓	8.5 [8.90] ↗
<b>Serie 2:</b>	8.8 [4.95] ←	10.1 [6.46] →	9.1 [7.69] ↑	7.5 [8.70] ↗	7.4 [9.67] ↗
<b>Serie 3:</b>	10.4* [5.35] ←	8.3 [7.08] →	7.9 [8.12] ↗	8.6 [8.96] ↗	8.1 [9.64] →
<b>Serie 4:</b>	9.5 [5.39] ↑	10.8* [6.54] ↗	8.7 [7.51] ↗	10.0 [8.49] →	9.9 [9.34] ↗
<b>Serie 5:</b>	8.4 [5.17] ↓	9.2 [6.36] ↑	10.8* [7.19] ↗	10.5* [8.07] ←	10.9* [9.13] ←
<b>Serie 6:</b>	8.8 [5.68] →	8.4 [7.19] ↗	9.6 [8.37] ↓	8.8 [9.50] ↗	0.0+ <sup>AST</sup> OOT ↗
<b>Serie 7:</b>	9.6 [5.14] ↓	9.6 [6.37] ↑	8.2 [7.52] ↗	8.5 [8.42] →	8.3 [9.16] ↗
<b>Serie 8:</b>	9.7 [5.93] ←	9.1 [7.14] ↑	8.1 [8.15] ↗	9.2 [8.92] ↗	10.2 [9.64] ↗

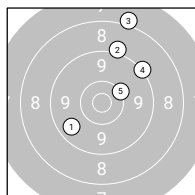
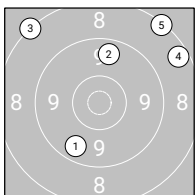
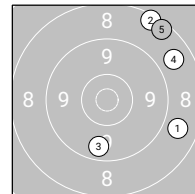
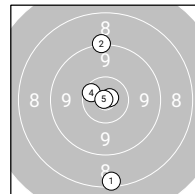
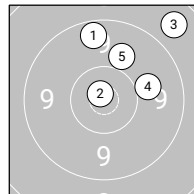
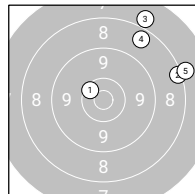
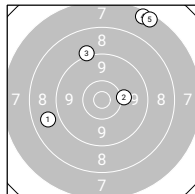
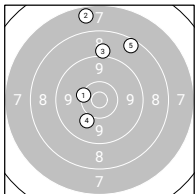

**Fußnoten-Legende:**

- AST - Treffer wurde nach Ende der Schießzeit abgegeben
- OOT - Treffer wurde außerhalb der Schießzeit abgegeben



Ergebnis: **146** (159.0)

Wertung: 146                      Serien: 13 4 30 19 16 21 14 29

Zähler: 2 2 3 2 3 2 4 6 3 2 8

Innenzehner: 2

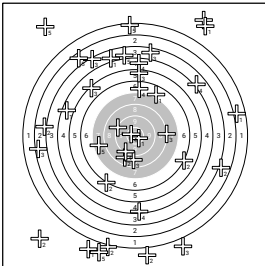

Wertung

**Wertung**

<b>Serie 1:</b>	0.0 [4.78] ↗	6.2 [5.91] ↘	3.6 [7.41] ↑	4.7 [8.65] ↑	0.0 [9.03] ↘
<b>Serie 2:</b>	4.6 [6.83] ↖	0.0 [8.99] ↘	0.0 [9.56] ↘		
<b>Serie 3:</b>	10.6* [5.25] ↘	8.9 [6.38] ↘	8.9 [7.99] ↓	4.4 [8.85] ↓	
<b>Serie 4:</b>	3.9 [5.78] ↗	1.0 [7.36] ↘	8.2 [8.53] →	4.0 [9.44] ↗	3.9 [9.99] ↑
<b>Serie 5:</b>	2.0 [5.58] →	0.0 [6.81] ↓	5.4 [8.38] ↖	9.3 [8.90] ↖	0.0 [9.70] ↘
<b>Serie 6:</b>	0.0 [5.54] ↘	3.1 [6.80] ←	2.5 [8.21] ←	9.4 [8.92] ↘	7.7 [9.24] ←
<b>Serie 7:</b>	0.0 [5.38] ↗	3.0 [6.54] →	3.4 [7.43] ↖	6.9 [8.52] ↑	2.7 [9.15] ↖
<b>Serie 8:</b>	7.0 [5.65] ↗	6.2 [6.53] →	5.5 [7.73] ↑	10.6* [8.33] ↖	1.4 [8.68] ↑

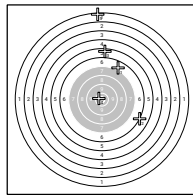
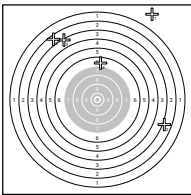
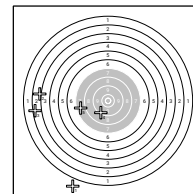
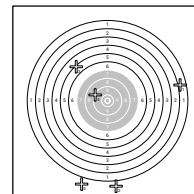
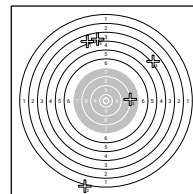
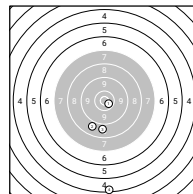
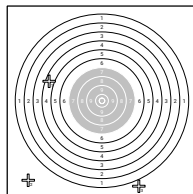
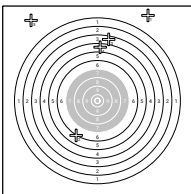

Ergebnis: **286** (303.6)

Wertung: 286                      Serien: 29 34 33 40 37 36 40 37

Zähler: 3 7 8 8 7 5 0 2 0 0 0

Innenzehner: 0

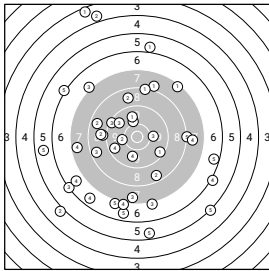

Wertung

**Wertung**

<b>Serie 1:</b>	3.5 [4.47] ↗	3.9 [5.35] ↗	8.5 [6.09] ↙	9.6 [6.93] ↙	6.2 [8.36] ↘
<b>Serie 2:</b>	9.4 [5.67] ↘	8.6 [6.64] ↙	6.2 [7.72] ↙	6.1 [8.70] ↘	5.7 [9.42] ↙
<b>Serie 3:</b>	5.9 [5.66] ↑	10.1 [6.51] ↙	7.1 [7.09] ↓	6.7 [7.77] ↙	5.2 [8.98] ↘
<b>Serie 4:</b>	8.0 [5.23] ↗	8.6 [6.01] ↘	10.1 [6.64] →	7.6 [7.83] ↙	7.1 [8.41] ↘
<b>Serie 5:</b>	7.4 [4.58] ↗	8.7 [5.56] ↗	7.6 [6.91] ↓	9.8 [7.62] ↓	6.7 [8.62] ↓
<b>Serie 6:</b>	8.3 [5.25] ↑	5.0 [6.15] ↙	9.3 [7.24] ↙	6.8 [8.16] ↙	8.2 [8.81] →
<b>Serie 7:</b>	10.1 [4.31] ↗	9.0 [5.18] ↙	9.7 [6.51] ↙	7.1 [7.11] ↓	5.6 [7.75] ↓
<b>Serie 8:</b>	9.8 [5.02] ↗	8.9 [6.18] ↙	7.1 [6.84] ↙	7.9 [7.73] →	6.5 [8.55] →

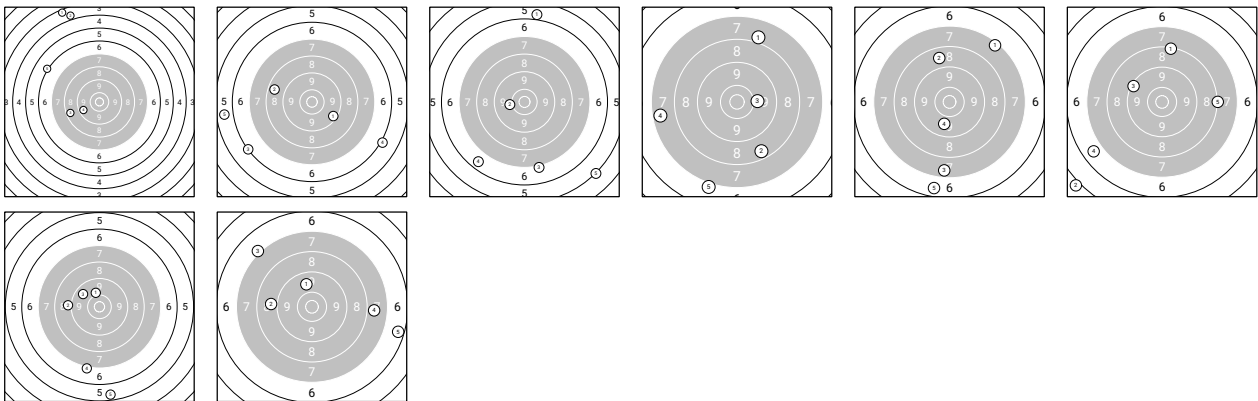

Ergebnis: **320** (338.1)

Wertung: 320                      Serien: 29 35 42 43 41 42 42 46

Zähler: 5 12 12 5 2 3 1 0 0 0 0

Innenzehner: 2

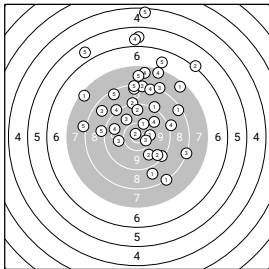

Wertung

**Wertung**

<b>Serie 1:</b>	7.5 [3.39] ↗	6.2 [4.70] ↗	5.7 [5.97] ↑	7.6 [7.02] ↑	4.4 [8.00] ↑
<b>Serie 2:</b>	8.9 [3.43] ↘	9.3 [4.64] ↘	8.4 [5.95] ↑	5.9 [7.13] ↑	5.8 [8.34] ↘
<b>Serie 3:</b>	10.3 [3.18] →	9.8 [4.93] ↘	8.2 [6.22] →	9.8 [7.52] ↗	6.9 [8.60] ↗
<b>Serie 4:</b>	9.2 [3.42] ↗	10.8* [4.87] ↘	10.5* [6.13] ↘	7.4 [7.36] ↗	7.8 [8.46] ↑
<b>Serie 5:</b>	7.4 [3.46] ↘	8.3 [5.14] ↑	10.0 [6.11] ←	8.4 [7.19] ↑	8.1 [8.03] ←
<b>Serie 6:</b>	8.4 [3.74] ↗	9.5 [5.20] ↘	8.7 [6.49] ↘	9.2 [7.54] ↘	8.4 [8.49] ↘
<b>Serie 7:</b>	8.2 <sub>NAM</sub> [0.00] ↘	9.2 <sub>NAM</sub> [0.00] ↑	8.1 [1.41] ↗	9.1 [2.72] →	8.3 [3.71] ↑
<b>Serie 8:</b>	10.2 [3.56] ↗	9.5 [5.16] ↑	9.9 [6.35] ↘	9.7 [7.47] ←	9.1 [8.55] ←

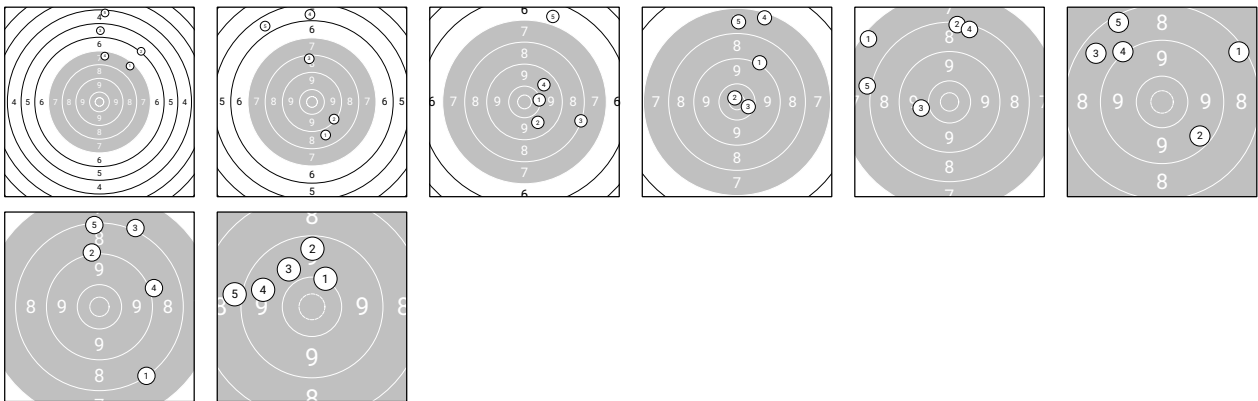

**Fußnoten-Legende:**

**NAM** - nicht anerkannte Waffenstörung



Ergebnis: **332** (348.6)

Wertung: 332                      Serien: 41 40 46 39 46 38 41 41

Zähler: 7 10 12 10 1 0 0 0 0 0 0

Innenzehner: 3

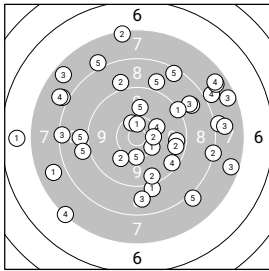

Wertung

**Wertung**

<b>Serie 1:</b>	9.1 [5.68] ↓	8.2 [6.33] →	8.3 [7.03] ←	8.0 [7.69] →	8.0 [8.27] ↖
<b>Serie 2:</b>	8.8 [4.51] →	7.7 [5.27] →	8.8 [6.23] →	7.6 [6.89] →	10.2 [7.56] ↓
<b>Serie 3:</b>	10.3 [5.23] →	9.5 [6.02] ↓	10.4* [6.82] ↖	9.6 [7.54] →	8.4 [8.27] ↗
<b>Serie 4:</b>	6.8 [5.70] ←	9.6 [6.50] →	7.5 [7.32] →	8.0 [8.13] ↖	9.0 [8.77] ←
<b>Serie 5:</b>	10.5* [6.73] ↑	10.0 [7.46] ↘	8.8 [8.20] ↓	10.2 [8.88] →	8.1 [9.46] ↘
<b>Serie 6:</b>	8.1 [6.23] →	7.3 [6.88] ↑	7.5 [7.57] →	7.3 [8.13] ↘	9.0 [8.70] ←
<b>Serie 7:</b>	9.2 [5.16] →	9.0 [5.85] ↖	7.9 [6.53] →	7.9 [7.23] ↖	9.9 [7.92] ↑
<b>Serie 8:</b>	7.8 [5.79] ←	10.4* [6.57] →	7.6 [7.51] ↖	9.4 [8.34] →	8.9 [9.07] ↗

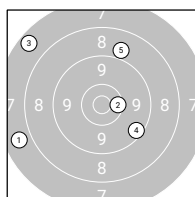
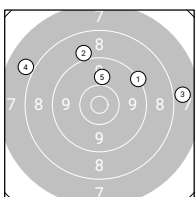
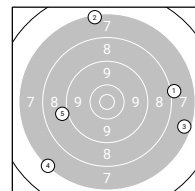
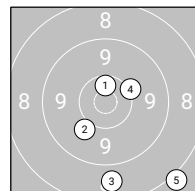
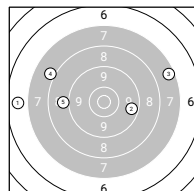
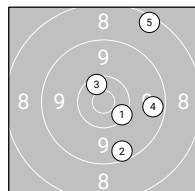
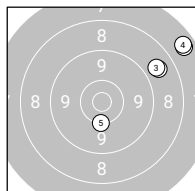
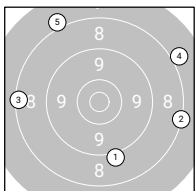

Ergebnis: **322** (339.2)

Wertung: 322                      Serien: 45 40 39 39 42 44 39 34

Zähler: 4 14 12 2 6 2 0 0 0 0 0

Innenzehner: 1

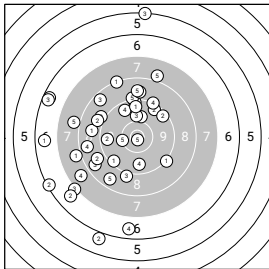

Wertung

**Wertung**

<b>Serie 1:</b>	9.2 [4.30] ↘	9.5 [6.08] ↗	9.1 [6.76] ↓	9.7 [7.64] ↓	9.3 [9.14] ↑
<b>Serie 2:</b>	10.0 [3.07] ↑	5.9 [4.22] ↓	7.2 [5.24] ↙	9.6 [6.27] ↗	9.1 [7.65] ↑
<b>Serie 3:</b>	8.2 [3.57] ↗	6.3 [4.68] ↙	9.0 [5.76] ↙	8.9 [6.81] ↑	8.8 [7.85] ↑
<b>Serie 4:</b>	8.8 [4.44] ↖	9.4 [5.78] ↗	8.6 [6.69] ↙	6.5 [7.81] ↙	8.6 [8.75] ↘
<b>Serie 5:</b>	9.4 [4.32] ↙	9.6 [5.30] ↖	6.5 [7.02] ↙	8.6 [7.69] ↖	10.2 [8.82] ↖
<b>Serie 6:</b>	8.0 [3.44] ↖	9.0 [4.67] ↖	10.0 [6.04] ↑	7.8 [6.93] ↙	10.8* [8.04] ↓
<b>Serie 7:</b>	9.6 [3.87] ↑	8.9 [4.93] ↙	8.5 [6.33] ↗	6.7 [7.19] ↓	8.0 [8.78] ↗
<b>Serie 8:</b>	6.7 [3.99] ↖	6.8 [5.95] ↙	5.2 [7.49] ↑	9.2 [8.67] ↗	8.0 [9.25] ↖

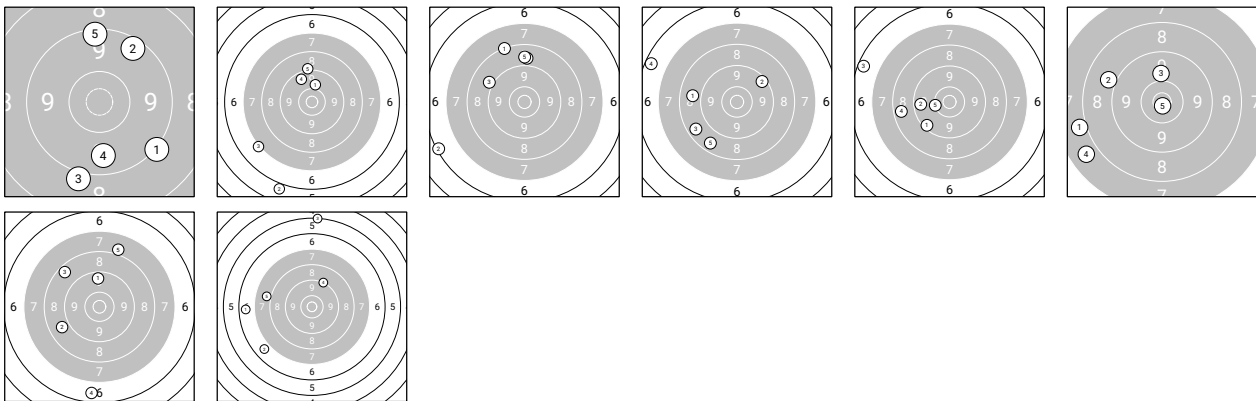

Ergebnis: **234** (251.4)

Wertung: 234                      Serien: 17 31 34 27 34 34 29 28

Zähler: 2 5 2 7 7 8 3 2 1 2 0

Innenzehner: 0

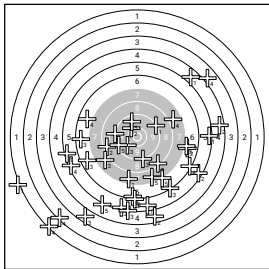

Wertung

**Wertung**

<b>Serie 1:</b>	1.1 [4.35] ←	7.0 [5.23] →	3.7 [5.90] ↓	1.3 [6.97] ↓	5.1 [7.60] ↓
<b>Serie 2:</b>	6.4 [3.90] ↓	5.5 [5.31] →	10.0 [6.06] ←	3.9 [6.61] →	7.1 [7.00] →
<b>Serie 3:</b>	4.8 [3.63] ↗	8.5 [4.86] ←	9.2 [6.08] ↓	6.3 [6.56] →	7.7 [7.00] ↓
<b>Serie 4:</b>	5.6 [4.12] ↓	10.1 [4.83] ↗	7.9 [5.64] ←	5.4 [6.92] ←	
<b>Serie 5:</b>	5.4 [4.29] →	9.2 [5.88] ←	6.3 [6.48] ↓	7.9 [7.12] →	7.3 [7.86] ↓
<b>Serie 6:</b>	9.3 [4.06] ↗	4.6 [5.36] →	6.6 [6.12] ←	6.9 [6.67] ←	9.7 [7.28] ↗
<b>Serie 7:</b>	5.4 [3.97] ←	4.7 [5.32] ↓	6.7 [6.31] ←	8.4 [6.90] ↓	6.2 [7.45] ↓
<b>Serie 8:</b>	7.7 [4.52] ↓	5.4 [5.36] ↓	5.3 [5.94] ↓	2.4 [6.64] ↓	9.4 [7.43] ←

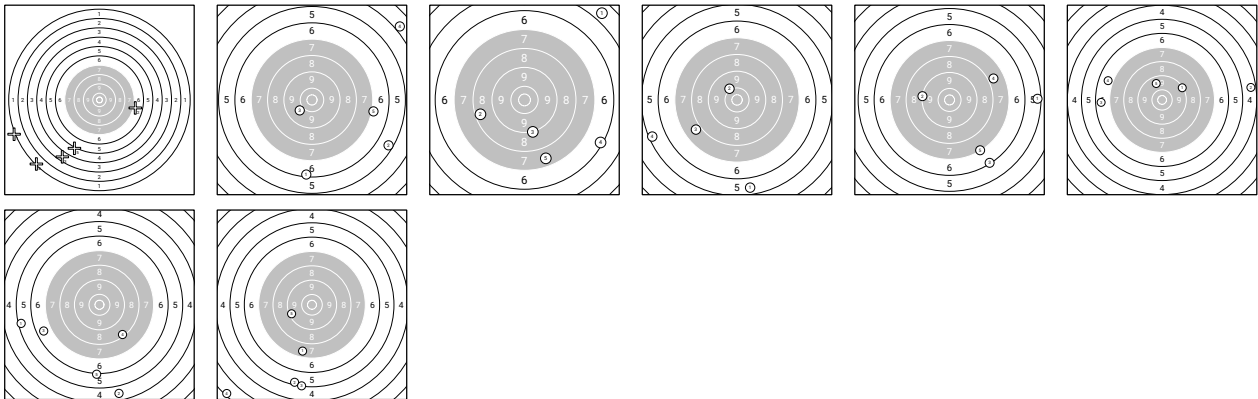

Ergebnis: **322** (340.6)

Wertung: 322                      Serien: 44 39 37 35 41 43 37 46

Zähler: 4 12 13 5 5 1 0 0 0 0 0

Innenzehner: 2

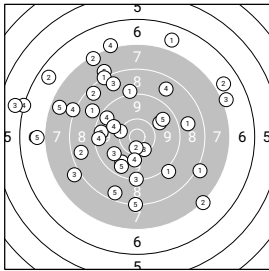

Wertung

**Wertung**

<b>Serie 1:</b>	10.2 [4.71] ←	9.9 [5.74] →	9.5 [6.75] ←	8.1 [7.93] ←	8.2 [9.23] ↓
<b>Serie 2:</b>	9.1 [4.58] ↑	8.5 [5.54] ↖	9.3 [6.63] ↓	6.2 [7.53] ←	7.6 [8.86] ←
<b>Serie 3:</b>	8.8 [4.45] →	8.6 [5.57] ←	5.9 [6.88] ←	7.1 [7.89] ↑	9.8 [9.12] ↘
<b>Serie 4:</b>	6.8 [4.40] ↗	6.9 [5.49] ↗	7.1 [6.68] →	8.7 [8.09] ↗	8.5 [9.83] ↘
<b>Serie 5:</b>	8.1 [4.72] ↘	7.2 [5.87] ↘	8.0 [7.14] ←	9.5 [8.18] ←	9.6 [9.49] ↘
<b>Serie 6:</b>	9.1 [3.76] ↘	7.3 [5.08] ↖	10.4* [6.40] ↘	9.9 [7.20] ←	8.0 [8.47] ↖
<b>Serie 7:</b>	8.2 [3.97] ↖	6.7 [5.04] ←	8.6 [6.13] ↖	9.4 [6.99] ←	6.9 [8.80] ←
<b>Serie 8:</b>	8.9 [4.54] ←	10.5* [6.06] ↓	9.8 [6.99] ←	10.0 [8.14] ↓	9.7 [9.27] ↗

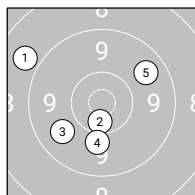
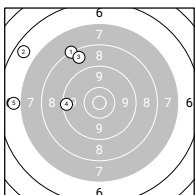
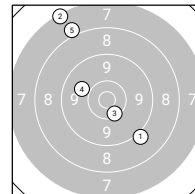
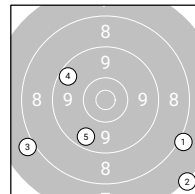
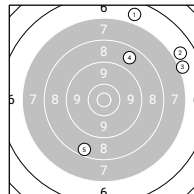
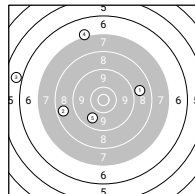
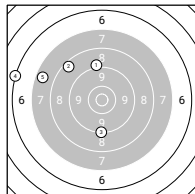
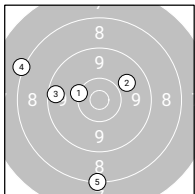

Ergebnis: **278** (292.4)

Wertung: 278                      Serien: 35 33 43 32 35 32 33 35

Zähler: 1 7 6 9 10 6 1 0 0 0 0

Innenzehner: 0

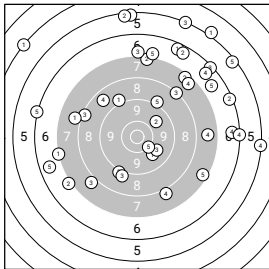

Wertung

**Wertung**

<b>Serie 1:</b>	5.1 [3.31] ↗	9.1 [4.60] ↘	8.0 [5.60] ↘	6.6 [6.44] →	7.5 [6.95] ↘
<b>Serie 2:</b>	6.5 [3.33] ↗	9.8 [4.61] ↗	8.3 [5.22] ↖	5.3 [5.70] →	5.4 [6.23] ↗
<b>Serie 3:</b>	9.9 [3.78] ↘	7.4 [4.65] ↗	9.9 [5.25] ↘	8.7 [6.02] ↖	10.3 [6.59] ↘
<b>Serie 4:</b>	7.2 [3.92] ↖	7.4 [4.86] ↑	6.3 [5.89] ↗	6.7 [7.14] ↗	6.7 [8.05] ↖
<b>Serie 5:</b>	5.3 [4.92] ↑	6.4 [5.89] ↗	8.2 [6.43] ↗	7.6 [7.01] ↗	9.1 [7.53] ↗
<b>Serie 6:</b>	9.1 [0.00] ↘	5.4 [0.00] ↑	5.2 [0.00] ↗	6.3 <sub>NAM</sub> [0.00] →	7.1 <sub>NAM</sub> [0.00] ↑
<b>Serie 7:</b>	4.2 [3.30] ↖	6.6 [4.59] ↗	9.0 [6.04] ↘	8.0 [6.70] ↘	6.8 [7.38] ↗
<b>Serie 8:</b>	8.0 [3.16] ↖	7.1 [3.92] ↘	7.0 [4.86] ↑	7.7 [5.49] →	6.2 [6.07] ↖

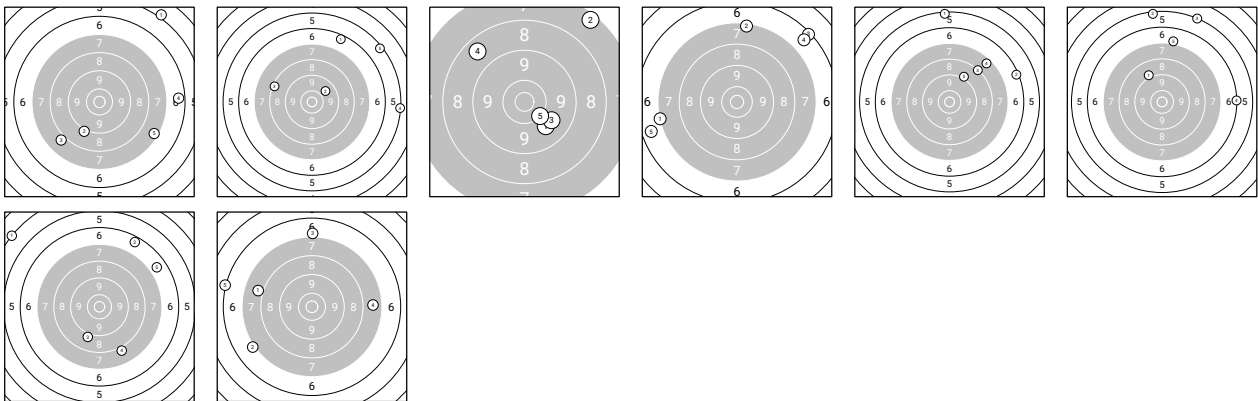

**Fußnoten-Legende:**

**NAM** - nicht anerkannte Waffenstörung



Ergebnis: **323** (343.3)

Wertung: 323                      Serien: 40 37 36 41 45 43 44 37

Zähler: 5 15 6 9 3 1 1 0 0 0 0

Innenzehner: 2

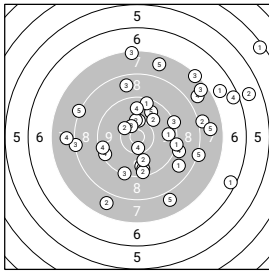

Wertung

**Wertung**

<b>Serie 1:</b>	8.8 [4.90] ↘	8.1 [6.09] →	8.3 [6.76] ←	7.8 [7.79] ↗	9.7 [8.46] ↗
<b>Serie 2:</b>	4.4 [3.79] ↗	7.8 [5.35] ↘	8.7 [6.07] ↑	9.0 [7.17] ↘	9.7 [7.94] ↓
<b>Serie 3:</b>	6.5 [5.34] ↘	9.9 [6.66] ↗	7.3 [7.50] ↗	7.9 [8.50] ←	7.7 [8.96] ↗
<b>Serie 4:</b>	9.5 [3.72] ↓	9.4 [5.40] ↓	7.3 [6.70] ↑	6.5 [7.79] ↗	10.2 [9.22] ↑
<b>Serie 5:</b>	9.4 [4.19] ↗	10.2 [5.28] ↑	10.4* [6.11] ↘	9.7 [8.08] ↑	7.9 [8.75] ↘
<b>Serie 6:</b>	9.2 [3.74] ↘	9.9 [5.06] ↓	7.5 [6.65] ↗	10.5* [7.44] ↓	8.2 [8.67] ←
<b>Serie 7:</b>	9.6 [4.39] ↘	10.3 [5.05] ↘	9.2 [6.11] ↗	9.4 [7.27] ←	7.8 [8.58] →
<b>Serie 8:</b>	6.9 [3.64] ↗	5.8 [4.49] →	9.3 [5.91] ↓	9.4 [7.10] ←	8.2 [8.54] ↘

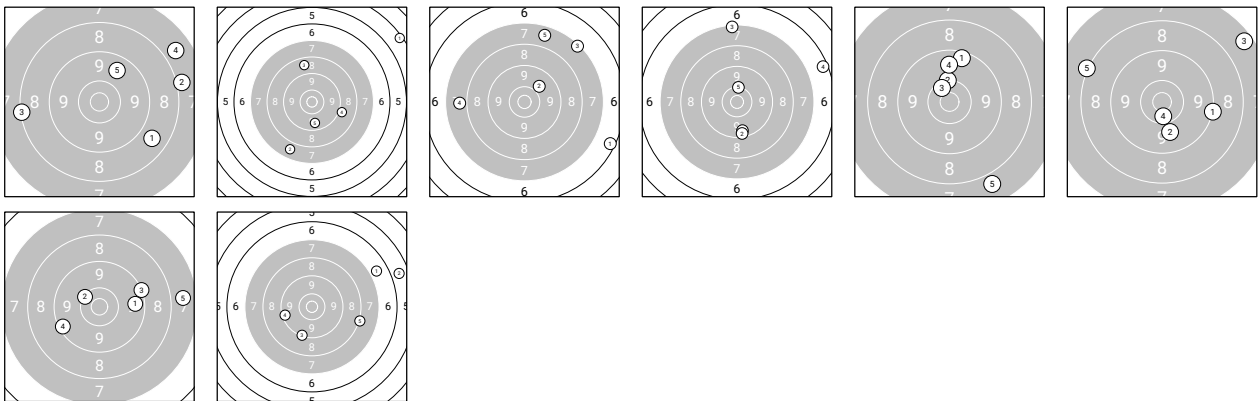

Ergebnis: **345** (365.0)

Wertung: 345                      Serien: 42 45 40 43 46 44 40 45

Zähler: 8 15 11 6 0 0 0 0 0 0

Innenzehner: 4

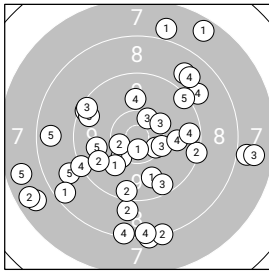

Wertung

**Wertung**

<b>Serie 1:</b>	7.9 [3.59] ↑	9.0 [4.63] ↓	9.4 [5.71] ↖	9.9 [6.73] ↑	8.9 [7.82] ↙
<b>Serie 2:</b>	8.2 [3.82] ↓	10.4* [4.81] ➔	10.2 [5.82] ➔	8.9 [6.83] ↗	9.5 [7.81] ↖
<b>Serie 3:</b>	7.6 [3.81] ↗	9.3 [4.89] ➔	8.8 [5.97] ↗	9.9 [6.92] ➔	7.7 [7.89] ↙
<b>Serie 4:</b>	9.8 [3.43] ↓	8.2 [4.40] ↓	9.5 [5.38] ↓	9.2 [6.37] ↖	8.0 [7.40] ➔
<b>Serie 5:</b>	10.3 [4.00] ↗	9.5 [5.12] ↓	10.4* [6.27] ↗	8.3 [7.22] ↓	9.8 [8.13] ↖
<b>Serie 6:</b>	10.0 [5.06] ↗	10.4* [6.12] ↖	9.4 [7.01] ↖	8.8 [8.17] ↗	7.7 [8.73] ↖
<b>Serie 7:</b>	8.5 [4.59] ↖	7.6 [5.51] ↖	7.8 [6.43] ➔	9.5 [7.42] ➔	9.3 [8.35] ↗
<b>Serie 8:</b>	10.6* [4.85] ↓	9.7 [5.74] ↖	10.2 [6.72] ➔	8.3 [7.80] ↓	8.6 [8.56] ↖

