

Ergebnis: **289** (307.1)

Wertung: 289 Serien: 41 43 34 40 31 37 31 32

Zähler: 1 9 10 7 8 3 1 0 1 0 0

Innenzehner: 0

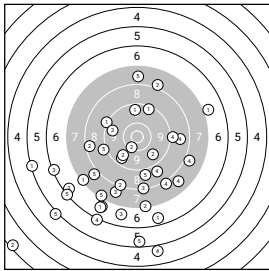

Wertung

Wertung

Serie 1:	9.4 [4.41] ↗	8.1 [5.93] ↗	7.9 [7.21] ↓	8.0 [8.35] ➤	9.1 [9.59] ↙
Serie 2:	9.2 [4.11] ↖	9.7 [5.74] ➤	9.6 [6.98] ↙	8.7 [8.30] ➡	8.9 [9.59] ↓
Serie 3:	7.4 [4.18] ↙	7.3 [5.53] ↓	6.5 [7.02] ↙	9.1 [8.15] ➡	5.1 [9.42] ↙
Serie 4:	9.5 [4.07] ↑	10.3 [5.21] ↓	6.9 [6.39] ↙	8.9 [7.44] ➤	7.8 [8.42] ↑
Serie 5:	6.6 [3.94] ↓	2.4 [5.30] ↙	8.3 [6.62] ↓	7.8 [7.91] ➤	8.0 [9.04] ↙
Serie 6:	6.8 [0.00] ↓	8.3 [0.00] ↓	9.6 [0.00] ↖	8.1 _{NAM} [0.00] ↓	6.2 _{NAM} [0.00] ↙
Serie 7:	5.3 [4.61] ↖	9.8 [5.81] ↙	6.8 [7.15] ↓	6.2 [8.33] ↓	5.5 [9.56] ↓
Serie 8:	7.0 [4.55] ➡	8.4 [5.74] ↖	6.3 [7.06] ↙	4.9 [8.22] ↓	7.4 [9.35] ↙

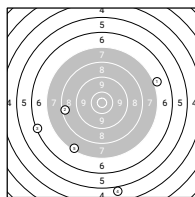
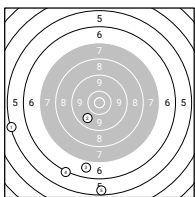
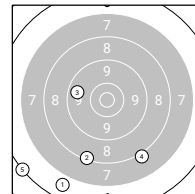
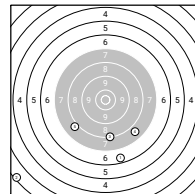
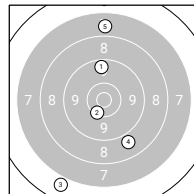
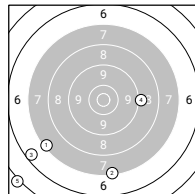
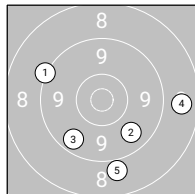
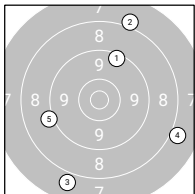

Fußnoten-Legende:

NAM - nicht anerkannte Waffenstörung



Ergebnis: **315** (334.5)

Wertung: 315 Serien: 36 41 38 42 43 43 31 41

Zähler: 5 10 13 8 1 1 1 0 0 0 0

Innenzehner: 2

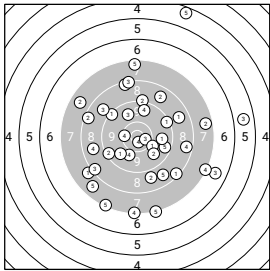

Wertung

Wertung

Serie 1:	9.4 [2.61] ↗	7.7 [3.80] ↘	6.8 [5.04] ↘	10.7* [6.88] ↓	4.5 [7.92] ↗
Serie 2:	8.0 [2.40] ↙	9.2 [3.47] ↑	10.5* [4.66] ↗	7.3 [5.94] ↘	7.2 [7.61] ↓
Serie 3:	8.4 [2.71] ↘	8.7 [3.86] ↗	5.7 [4.78] →	10.3 [6.20] ↙	7.7 [7.32] ↙
Serie 4:	10.1 [2.62] ↘	9.8 [4.09] ↘	8.4 [5.58] ↑	8.7 [6.42] ↙	7.4 [7.31] ↑
Serie 5:	9.3 [4.11] ↘	7.6 [5.38] →	8.3 [6.45] ↑	10.0 [7.96] ↓	9.5 [9.09] ↗
Serie 6:	9.7 [2.89] →	9.4 [3.81] ↙	9.8 [5.10] ↗	8.5 [6.62] →	8.7 [7.73] ↘
Serie 7:	8.7 [3.81] ↗	8.9 [4.88] ↓	8.8 [6.04] ↘	7.3 [7.26] ↓	
Serie 8:	9.8 [3.02] ↙	8.4 [4.24] ↘	8.4 [5.63] ↙	9.6 [6.95] ↗	7.3 [8.20] ↓

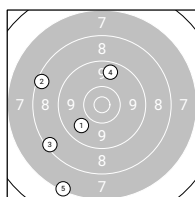
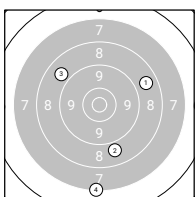
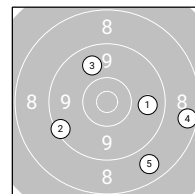
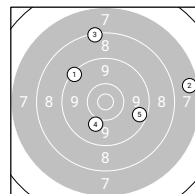
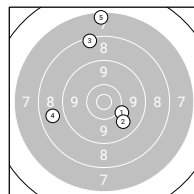
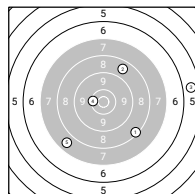
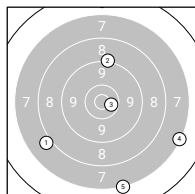
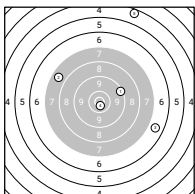

Ergebnis: **310** (325.6)

Wertung: 310 Serien: 41 37 40 42 28 41 40 41

Zähler: 7 6 13 4 7 1 1 1 0 0 0

Innenzehner: 1

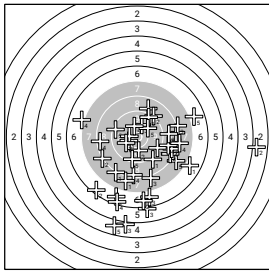

Wertung

Wertung

Serie 1:	10.3 [3.45] ↙	10.0 [4.82] ↓	6.1 [5.76] ↓	8.4 [6.78] ↓	7.9 [7.68] ➤
Serie 2:	7.9 [3.66] ↓	6.7 [5.02] ↓	10.1 [5.97] ↑	6.4 [7.01] ↓	8.4 [8.13] →
Serie 3:	8.9 [3.16] ↗	9.2 [4.26] ↗	6.9 [5.29] ↓	8.5 [6.28] ←	9.4 [7.26] ↓
Serie 4:	9.1 [3.73] ➤	8.2 [5.01] ↙	8.1 [6.12] ↓	8.5 [7.23] ➤	9.4 [8.39] ←
Serie 5:	8.2 [3.68] ↓	3.0 [5.20] →	5.1 [6.40] ↓	8.5 [7.42] ➤	4.8 [8.34] ↓
Serie 6:	9.4 [3.55] ↗	6.5 [4.84] ↙	8.2 [5.63] →	8.8 [6.73] ➤	10.0 [7.77] ↗
Serie 7:	7.0 _{NAM} [0.00] ➤	6.7 _{NAM} [0.00] ↓	10.4* [0.61] ←	7.1 [1.57] ←	10.2 [4.13] ↗
Serie 8:	9.4 [3.52] ➤	10.1 [4.66] ↙	8.8 [5.72] →	8.1 [6.61] ➤	6.9 [7.62] ➤

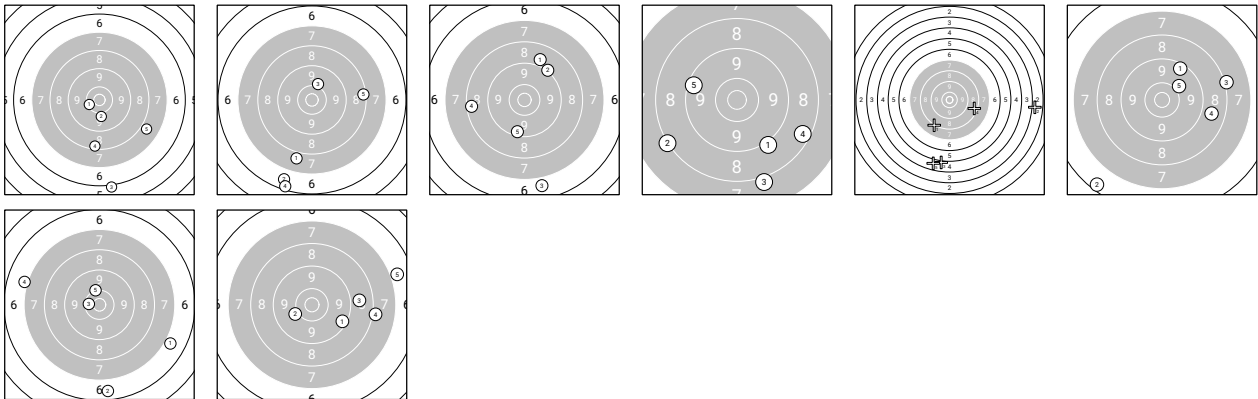

Fußnoten-Legende:

NAM - nicht anerkannte Waffenstörung



Ergebnis: **302** (321.1)

Wertung: 302 Serien: 41 40 37 35 34 34 40 41

Zähler: 1 6 18 8 3 4 0 0 0 0 0

Innenzehner: 0

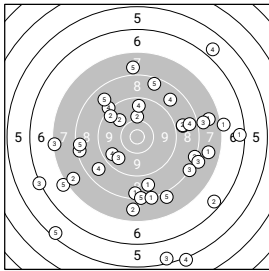

Wertung

Wertung

Serie 1:	6.4 [3.31] →	10.1 [4.80] ↑	8.3 [6.53] ←	9.2 [7.68] ↗	8.8 [8.52] ↘
Serie 2:	8.5 [2.95] ↓	8.3 [4.98] →	8.1 [7.40] →	9.6 [8.47] ↙	7.1 [9.41] ↙
Serie 3:	8.9 [2.53] →	6.5 [4.49] →	7.3 [6.16] ←	8.8 [7.63] ↗	8.5 [8.36] ↗
Serie 4:	7.7 [3.89] →	7.6 [5.51] ↙	5.5 [6.88] ↓	8.7 [7.93] ↙	8.3 [8.88] ↓
Serie 5:	8.2 [3.46] ↓	7.8 [5.36] ↓	6.2 [6.79] ←	5.9 [8.01] ↗	8.4 [9.23] ←
Serie 6:	7.1 [3.04] →	9.9 [4.33] ↗	8.0 [5.95] →	5.1 [7.42] ↓	5.4 [8.75] ↙
Serie 7:	7.7 _{NAM} [0.00] →	8.9 [0.67] →	9.7 [1.83] ↙	9.6 [2.92] ↑	7.9 [4.02] ↑
Serie 8:	8.8 [3.02] ↓	9.5 [4.71] ↘	8.2 [6.12] →	8.6 [7.28] →	8.0 [9.25] ↓

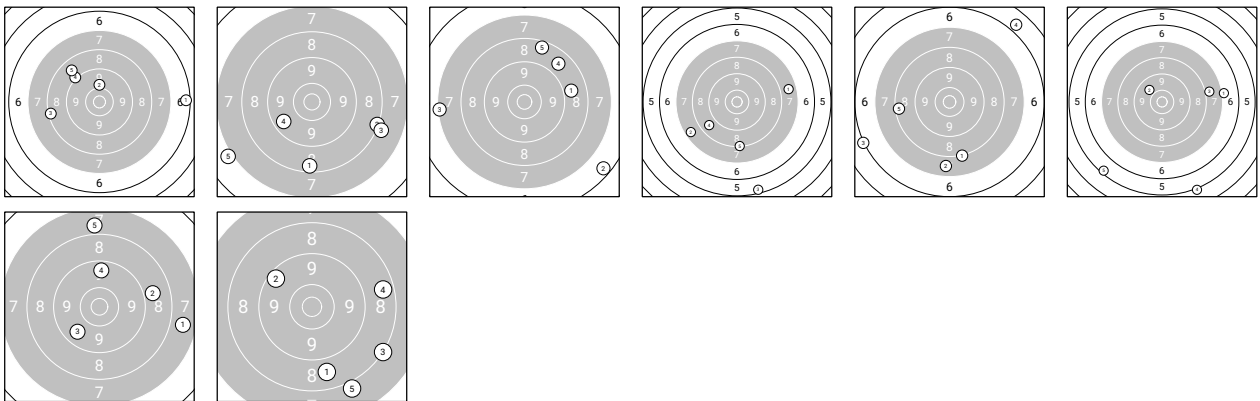

Fußnoten-Legende:

NAM - nicht anerkannte Waffenstörung



Ergebnis: **312** (330.0)

Wertung: 312 Serien: 44 44 39 37 37 35 30 46

Zähler: 6 9 8 12 1 2 1 1 0 0 0

Innenzehner: 0

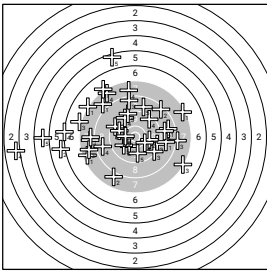

Wertung

Wertung

Serie 1:	7.5 [4.94] ←	10.2 [5.79] ↓	8.1 [6.80] →	9.5 [7.87] ↗	10.0 [8.52] ↙
Serie 2:	8.7 [4.24] →	8.5 [5.91] ↗	9.4 [7.04] ↖	9.5 [7.99] ↖	10.2 [8.96] ←
Serie 3:	7.2 [5.77] ↖	9.4 [6.38] →	7.1 [6.99] ←	7.8 [7.75] ↑	9.3 [8.70] ↑
Serie 4:	8.9 [4.90] →	7.9 [5.87] ←	9.4 [6.73] ↘	8.7 [7.46] ←	5.4 [8.42] ↑
Serie 5:	7.9 [4.86] ↘	7.9 [6.42] ↓	7.3 [7.68] ↘	7.5 [8.66] ↘	9.8 [9.31] ↓
Serie 6:	7.4 [5.05] ↗	9.0 [6.23] →	9.8 [7.30] ↖	6.2 [8.05] ←	4.8 [8.79] ←
Serie 7:	7.1 [5.14] ↘	5.9 [6.50] ←	7.8 [7.08] ←	3.0 [8.24] ←	8.9 [8.80] ↗
Serie 8:	8.0 [3.99] ←	10.0 [5.77] →	8.5 [6.67] ↑	10.2 [7.67] ↘	10.3 [9.10] ←

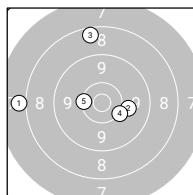
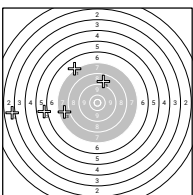
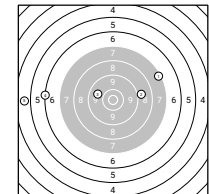
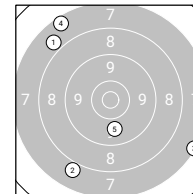
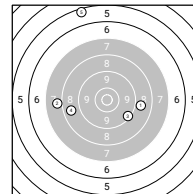
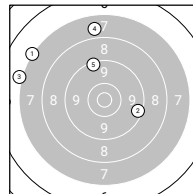
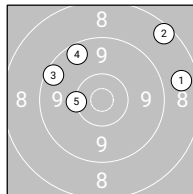
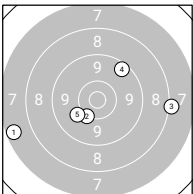

Ergebnis: **366** (382.8)
 Wertung: 366 Serien: 49 48 46 43 44 47 43 46
 Zähler: 17 14 7 2 0 0 0 0 0 0
 Innenezehner: 5

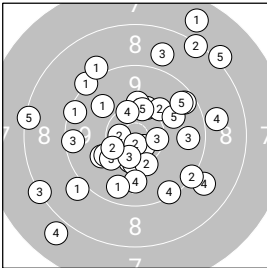

Wertung

Wertung

Serie 1:	9.4 [5.51] ←	10.6* [6.82] ←	10.2 [8.07] ↑	10.0 [9.02] ←	10.1 [9.80] ↑
Serie 2:	10.6* [3.65] ↘	10.7* [4.83] ↓	10.3 [5.87] ↓	8.9 [6.93] ↘	10.1 [8.28] ←
Serie 3:	9.0 [4.65] ←	9.2 [5.78] ↘	8.2 [7.02] ←	10.3 [7.99] ↓	10.1 [8.81] ←
Serie 4:	7.8 [5.36] ↑	10.1 [6.66] ↑	8.9 [7.68] ↑	9.3 [8.58] ↘	9.9 [9.31] →
Serie 5:	9.2 [3.92] ←	10.2 [5.11] ↓	10.4* [6.16] ↓	7.9 [7.20] ←	8.1 [8.13] ↑
Serie 6:	9.9 [5.05] ←	9.5 [6.60] →	10.4* [7.60] →	9.8 [8.34] ↓	10.3 [9.27] ↑
Serie 7:	9.0 [2.53] ↑	8.3 [3.56] ↑	9.4 [4.60] ←	8.9 [5.42] →	9.6 [6.26] →
Serie 8:	9.6 [4.60] ↓	10.3 [5.75] ←	9.7 [6.92] →	10.3 [7.94] ↑	8.3 [8.84] ←

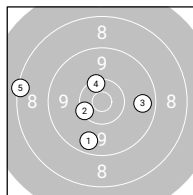
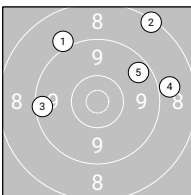
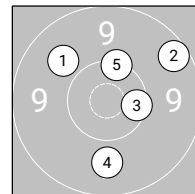
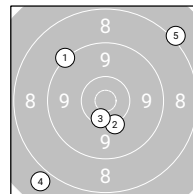
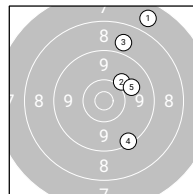
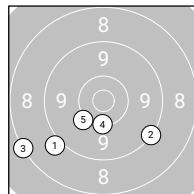
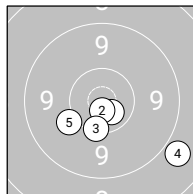
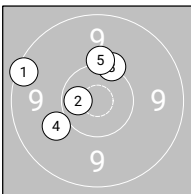

Ergebnis: **293** (306.4)

Wertung: 293 Serien: 38 45 31 33 37 37 35 37

Zähler: 2 12 6 9 5 3 1 1 1 0 0

Innenzehner: 0

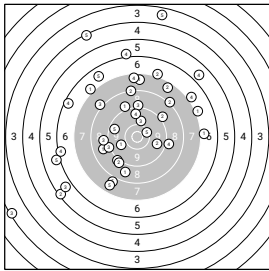

Wertung

Wertung

Serie 1:	7.6 [3.56] ↑	5.3 [4.81] ↙	9.2 [5.99] ↘	7.5 [7.31] ↑	10.3 [8.34] ↘
Serie 2:	9.9 [3.46] ↙	8.2 [4.88] ↗	10.0 [6.13] ↑	9.1 [7.64] →	9.5 [8.38] ↙
Serie 3:	9.0 [3.89] ↗	8.2 [5.06] ↑	2.3 [6.16] ↙	6.5 [6.94] ↙	6.0 [7.63] ↙
Serie 4:	7.0 [3.35] ↘	7.1 [4.61] ↗	5.8 [5.80] ↙	6.1 [6.94] ↑	8.0 [8.17] ↘
Serie 5:	8.8 [4.19] ↙	7.6 [5.51] ↗	9.2 [6.58] ↙	6.4 [7.83] ↙	7.7 [9.14] ↘
Serie 6:	8.8 [3.60] ↘	9.1 [5.40] ↘	9.1 [6.56] ↑	5.8 [7.61] ↗	6.7 [8.73] ↘
Serie 7:	7.1 [4.11] ↗	9.1 [5.49] ↗	8.1 [6.41] ↘	7.0 [7.65] ↗	4.3 [8.55] ↗
Serie 8:	7.0 [3.96] →	9.7 [5.00] ↘	9.0 [6.16] ↙	9.6 [7.39] ↑	3.7 [8.29] ↑

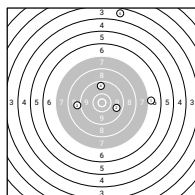
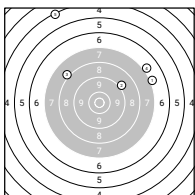
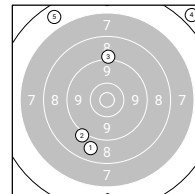
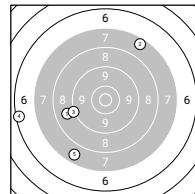
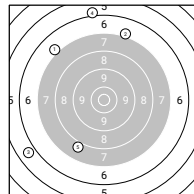
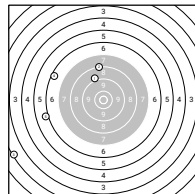
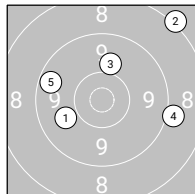
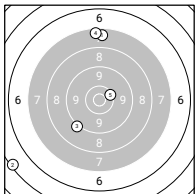

Ergebnis: **318** (335.6)

Wertung: 318 Serien: 32 40 43 38 40 41 47 37

Zähler: 5 14 9 6 3 1 0 1 1 0 0

Innenzehner: 2

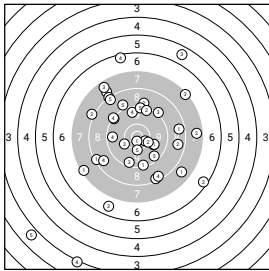

Wertung

Wertung

Serie 1:	8.3 [5.04] ↙	9.0 [7.20] ↑	7.9 [8.06] ↖	6.4 [8.61] ↑	2.8 [9.24] ↙
Serie 2:	7.8 [3.77] ↘	6.4 [4.80] ↘	9.1 [5.79] ↗	9.3 [7.45] ↖	9.9 [8.30] ↘
Serie 3:	8.4 [3.45] ↘	10.5* [5.58] ↘	7.3 [6.95] ↗	9.6 [7.58] ←	9.0 [8.40] ↖
Serie 4:	8.6 [4.14] →	7.6 [5.25] →	6.7 [6.31] ↘	9.5 [7.22] ↑	8.2 [8.13] ↖
Serie 5:	9.9 [4.66] ↘	8.1 [5.59] ↖	7.6 [6.45] ↖	8.6 [7.50] ↙	8.4 [8.72] ↖
Serie 6:	9.3 [0.00] ↓	10.3 [0.00] ↘	5.7 [0.00] ↗	8.4 _{NAM} [0.00] ↘	9.3 _{NAM} [0.00] ↑
Serie 7:	10.7* [4.71] ↓	9.4 [5.79] ↗	9.4 [7.01] ↓	9.2 [7.87] ↖	10.2 [8.64] ↓
Serie 8:	7.4 [4.83] ↙	8.6 [7.48] →	10.1 [7.99] ↙	3.2 [8.52] ↘	9.5 [9.21] ↘

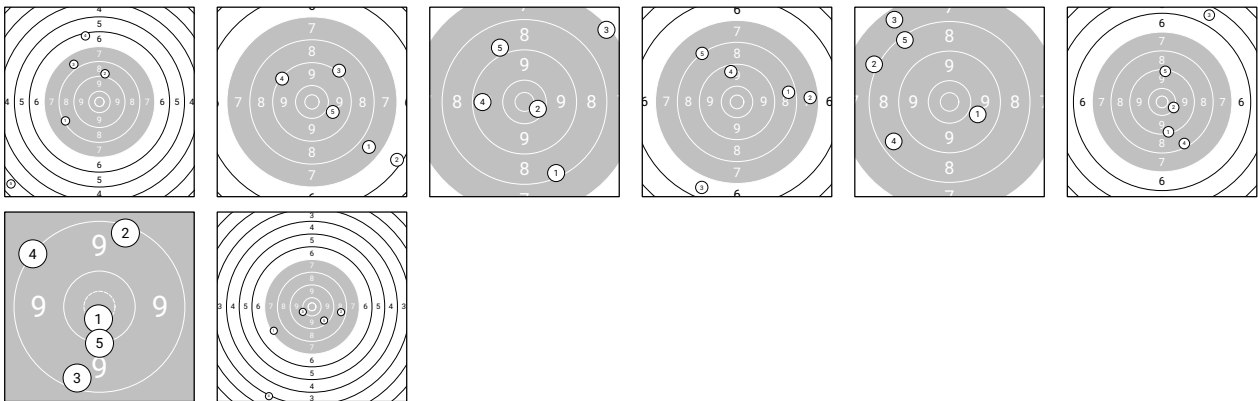

Fußnoten-Legende:

NAM - nicht anerkannte Waffenstörung



Ergebnis: **318** (336.1)

Wertung: 318 Serien: 37 38 40 41 37 47 40 38

Zähler: 6 10 10 6 6 2 0 0 0 0

Innenzehner: 4

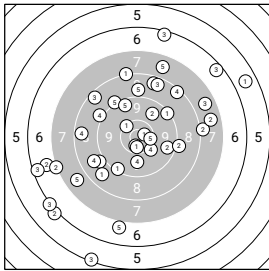

Wertung

Wertung

Serie 1:	10.6* [3.82] →	6.9 [5.07] ←	5.3 [6.34] ↓	9.0 [7.51] ↙	7.0 [8.72] ↓
Serie 2:	9.3 [3.84] ↘	7.2 [5.42] ←	6.4 [6.60] ↙	9.9 [7.68] ↓	7.8 [8.57] ↙
Serie 3:	9.3 [3.11] →	8.1 [4.33] →	6.4 [5.67] ↑	8.8 [6.99] ↙	9.2 [7.96] ↗
Serie 4:	8.7 [4.45] ↘	9.6 [5.63] →	6.5 [6.62] ↗	8.5 [7.59] ↑	10.6* [8.95] ↓
Serie 5:	5.7 [3.84] →	9.8 [4.96] ↗	7.7 [6.09] →	8.4 [7.17] ↗	8.9 [8.45] ↑
Serie 6:	10.3 [3.67] ↘	9.1 [5.10] →	8.5 [6.11] ↘	10.1 [7.31] ↘	10.4* [8.38] →
Serie 7:	10.5* _{NAM} [0.00] ↓	6.1 [0.81] ↙	6.2 [2.05] ↙	9.1 [3.05] ↙	9.5 [3.98] ↗
Serie 8:	8.2 [4.74] ↑	7.7 [5.71] →	8.5 [6.83] ↗	8.5 [7.96] ←	7.8 [8.97] ↗

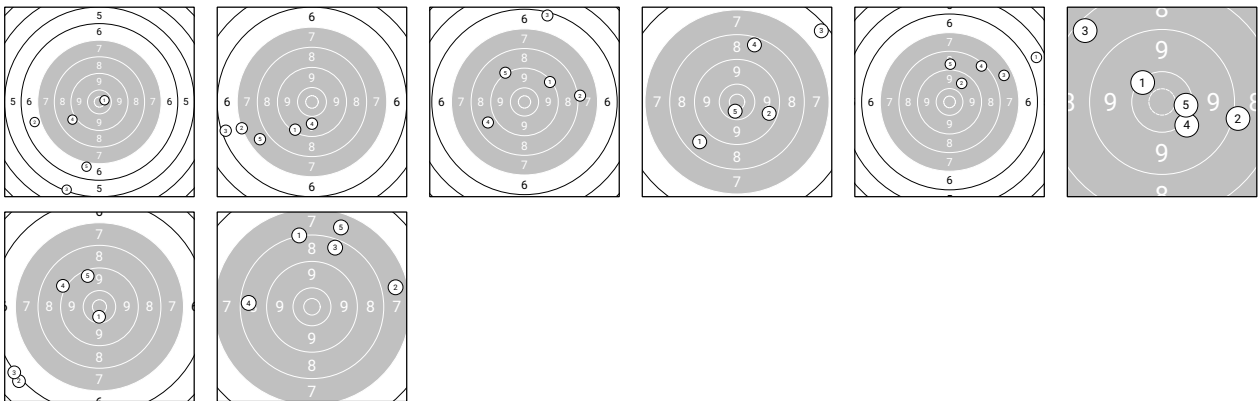

Fußnoten-Legende:

NAM - nicht anerkannte Waffenstörung



Ergebnis: **316** (335.5)

Wertung: 316 Serien: 40 44 43 38 41 44 42 24

Zähler: 2 15 15 5 1 0 0 0 0 2

Innenzehner: 0

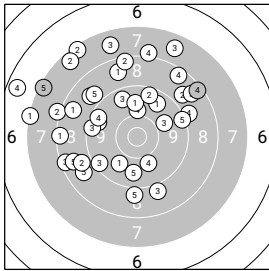

Wertung

Wertung

Serie 1:	7.3 [5.59] ←	8.1 [6.38] ←	9.4 [7.08] ←	8.5 [7.72] ↗	8.8 [8.35] ↙
Serie 2:	9.9 [4.65] ↘	8.9 [5.53] ↗	9.9 [6.89] ↗	9.0 [8.02] ↗	9.0 [8.75] ↓
Serie 3:	8.7 [4.65] ↑	7.4 [6.15] ↘	9.6 [7.09] ↗	10.1 [8.09] ↑	9.3 [9.10] →
Serie 4:	8.9 [4.50] ↘	8.4 [6.25] ↑	8.4 [7.57] ←	6.6 [8.32] ←	8.6 [9.65] ↗
Serie 5:	9.8 [3.74] ↑	9.6 [4.95] ←	7.7 [6.00] ↗	8.1 [6.95] ↑	8.7 [8.09] ←
Serie 6:	9.6 [4.95] ↗	9.5 [6.11] ↗	9.4 [6.94] ←	9.5 [7.83] ←	8.9 [8.69] ↘
Serie 7:	8.6 [5.77] ←	8.9 [6.68] ←	7.7 [7.76] ↗	10.0 [8.87] ↓	9.7 [9.71] ↓
Serie 8:	8.4 [5.42] ←	7.6 [7.03] ↘	9.0 [8.96] ↓	0.0+ ^{AST,OOT} ↗	0.0+ ^{AST,OOT} ↙

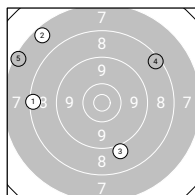
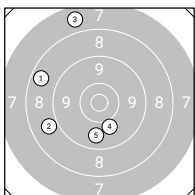
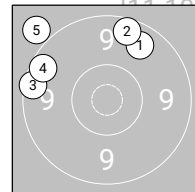
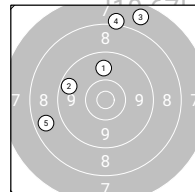
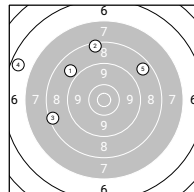
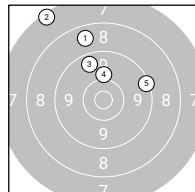
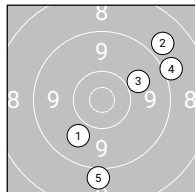
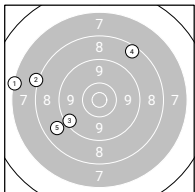

Fußnoten-Legende:

- AST - Treffer wurde nach Ende der Schießzeit abgegeben
- OOT - Treffer wurde außerhalb der Schießzeit abgegeben



Ergebnis: **300** (320.0)

Wertung: 300 Serien: 36 40 32 37 33 41 37 44

Zähler: 2 12 9 6 6 3 1 1 0 0 0

Innenzehner: 1

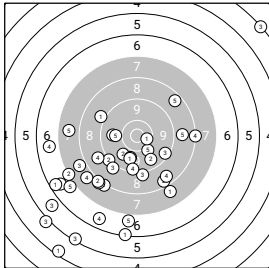

Wertung

Wertung

Serie 1:	4.4 [3.71] ↘	9.2 [5.27] ↘	9.1 [6.16] ↘	8.2 [7.07] →	6.9 [7.89] ↓
Serie 2:	8.2 [4.38] ↘	8.5 [5.99] ↘	5.1 [7.29] ↘	9.8 [8.11] ←	10.1 [9.16] ↘
Serie 3:	9.0 [4.55] ↘	6.7 [5.57] ↘	3.2 [7.04] ↗	6.7 [8.34] ↘	8.5 [9.64] ↗
Serie 4:	6.5 [4.42] ↘	9.9 [5.76] ↘	5.3 [7.23] ↘	8.6 [8.25] ↘	9.9 [9.12] ↘
Serie 5:	7.9 [4.30] ↘	8.1 [5.31] ↘	5.8 [6.25] ↘	6.8 [6.98] ←	7.0 [7.79] ↘
Serie 6:	10.5* [3.81] →	8.1 [4.95] ↘	9.1 [5.95] ↓	7.9 [6.96] ↘	7.7 [7.80] ←
Serie 7:	6.3 [3.30] ↓	7.3 [4.95] ↘	7.9 [5.96] ↘	8.8 [6.93] ↘	9.9 [7.89] ←
Serie 8:	9.8 [3.92] ↘	9.7 [5.32] ↘	9.4 [6.81] ↘	9.4 [7.72] ↓	8.8 [8.54] →

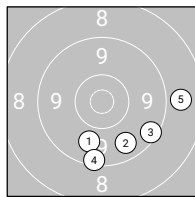
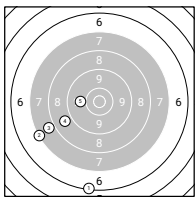
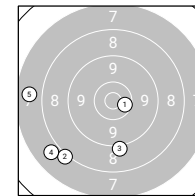
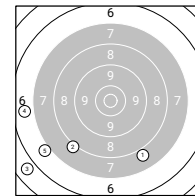
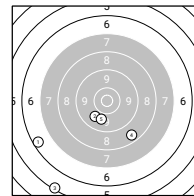
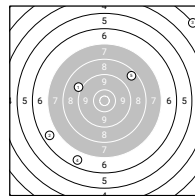
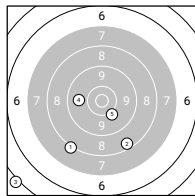
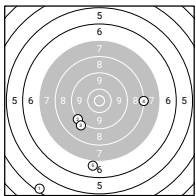

Ergebnis: **271** (286.0)

Wertung: 271 Serien: 32 37 34 30 31 31 37 39

Zähler: 2 6 8 9 5 6 2 0 1 0 1

Innenzehner: 0

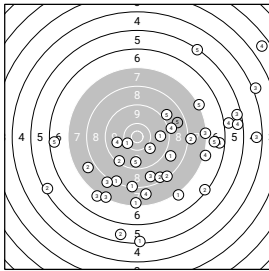

Wertung

Wertung

Serie 1:	8.3 [4.29] ↓	8.1 [5.69] →	4.1 [6.64] →	6.5 [8.04] →	6.8 [8.75] →
Serie 2:	8.3 [4.85] ↙	5.4 [6.26] ↙	8.0 [7.10] ↘	7.8 [7.97] ↓	9.6 [8.73] ↓
Serie 3:	5.3 [4.43] ↓	6.3 [5.35] ↘	8.7 [6.39] ↓	6.0 [7.72] →	9.0 [8.79] ↗
Serie 4:	8.9 [4.00] ↘	7.8 [5.29] ↙	7.1 [6.24] ↘	2.7 [7.77] ↗	6.5 [8.48] ↙
Serie 5:	7.1 [4.19] ↘	8.5 [5.53] ↓	4.5 [6.41] →	5.5 [7.64] →	7.2 [8.62] ↗
Serie 6:	9.7 [4.24] →	8.3 [5.79] ↘	5.5 [7.16] →	9.8 [8.56] ↙	0.0+ ^{AST} OOT →
Serie 7:	7.4 [4.22] ↓	9.3 [5.42] ↘	7.3 [6.49] →	9.1 [7.32] →	5.3 [9.00] ↗
Serie 8:	10.3 [4.44] ↙	5.6 [5.82] ↓	7.3 [6.61] ↘	7.1 [7.70] →	10.0 [8.51] ↘

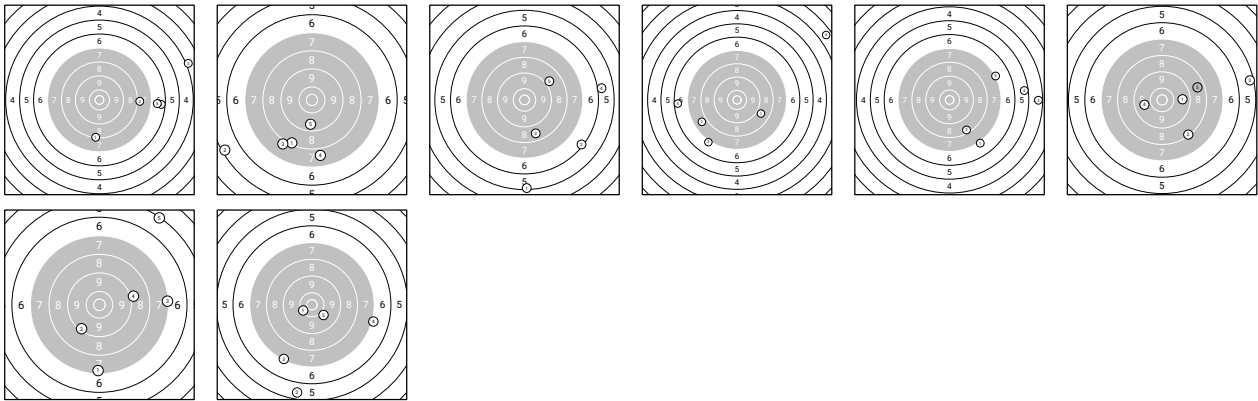

Fußnoten-Legende:

- AST - Treffer wurde nach Ende der Schießzeit abgegeben
- OOT - Treffer wurde außerhalb der Schießzeit abgegeben



Ergebnis: **308** (325.0)

Wertung: 308 Serien: 39 39 40 31 39 38 40 42

Zähler: 3 13 9 8 3 3 0 0 0 0 1

Innenzehner: 1

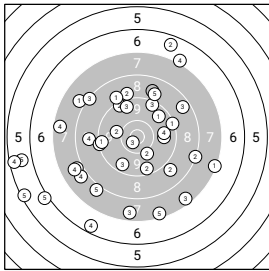

Wertung

Wertung

Serie 1:	8.0 [5.46] ↙	6.6 [6.64] ↗	8.6 [7.90] ↗	8.8 [8.72] ↙	9.8 [9.74] →
Serie 2:	7.3 [5.65] →	10.0 [6.65] ↙	9.4 [7.53] ↗	7.5 [8.28] ↙	6.1 [9.02] ↙
Serie 3:	9.3 [5.73] ↙	10.1 [6.43] ↘	7.6 [8.13] ↓	9.8 [8.77] →	5.8 [9.58] ↙
Serie 4:	9.4 [6.58] ↙	9.4 [8.06] ↗	7.5 [8.97] ↘	6.5 [9.66] ↓	0.0 ⁺ AST,OOT ↗
Serie 5:	9.3 [6.82] →	9.0 [7.67] ↗	9.6 [8.28] ↓	7.9 [8.75] ↙	5.4 [9.24] ↙
Serie 6:	8.0 [0.00] ↙	8.2 [0.00] →	9.6 [0.00] ↗	5.4 _{NAM} [0.00] ↙	8.9 _{NAM} [0.00] ↗
Serie 7:	9.0 [6.32] ↗	8.9 [7.27] ↘	8.3 [7.91] ↙	7.8 [8.56] ↙	8.0 [9.07] ↙
Serie 8:	9.6 [4.59] ↗	9.5 [5.56] ↓	10.6* [6.39] ↓	7.1 [7.75] ↗	7.4 [8.62] ↓

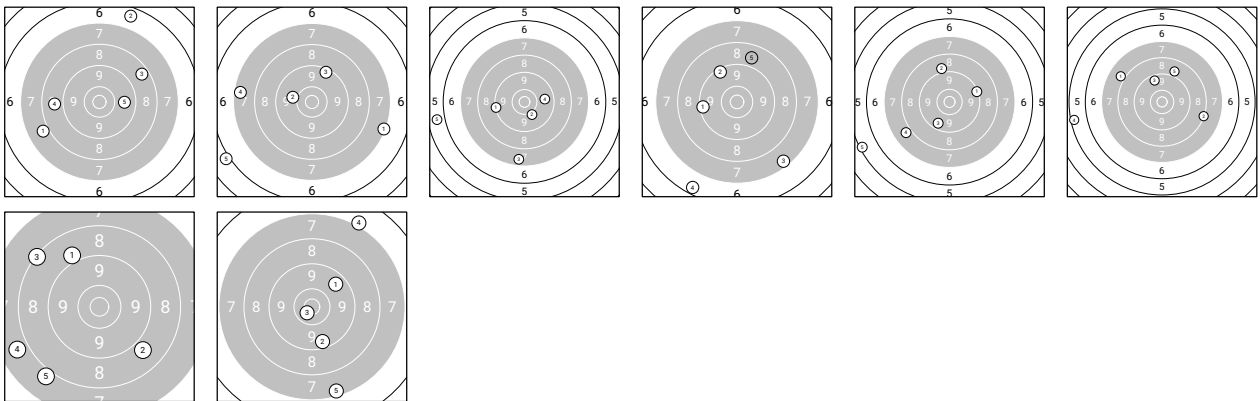

Fußnoten-Legende:

- NAM** - nicht anerkannte Waffenstörung
- AST** - Treffer wurde nach Ende der Schießzeit abgegeben
- OOT** - Treffer wurde außerhalb der Schießzeit abgegeben



Ergebnis: **213** (229.5)

Wertung: 213 Serien: 35 28 34 29 33 24 30

Zähler: 0 7 4 6 8 2 1 4 1 0 0

Innenzehner: 0

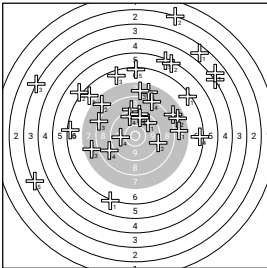

Wertung

Wertung

Serie 1:	6.4 [3.70] ↗	9.3 [5.24] ➔	6.6 [6.50] ↗	9.1 [7.61] ↑	5.4 [9.03] ↗
Serie 2:	6.1 [3.53] ↘	2.2 [4.58] ↗	8.0 [5.56] ➔	9.6 [6.54] ↑	3.3 [8.09] ↙
Serie 3:	3.7 [3.51] ↗	7.8 [4.75] ➔	8.2 [5.86] ↙	9.9 [7.28] ↙	7.8 [8.43] ↗
Serie 4:	9.7 [3.21] ↗	7.8 [4.70] ↙	7.8 [7.51] ↙	6.5 [8.54] ➔	
Serie 5:	4.2 [3.01] ↗	9.4 [4.27] ↑	6.4 [6.01] ↙	8.9 [7.20] ↙	6.7 [8.30] ↙
Serie 6:	7.9 [3.79] ➔	6.1 [5.10] ↙	3.2 [5.98] ↙	8.3 [9.05] ↗	
Serie 7:	3.9 [4.14] ↗	5.4 [4.93] ↗	7.8 [6.33] ↑	9.7 [7.26] ↗	6.4 [8.35] ↑

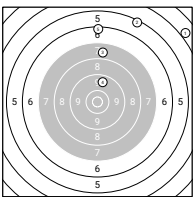
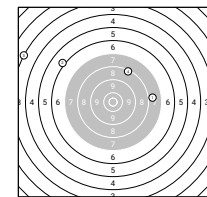
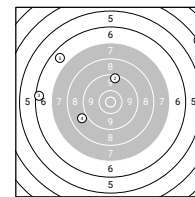
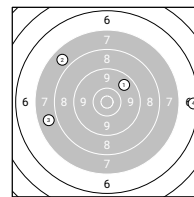
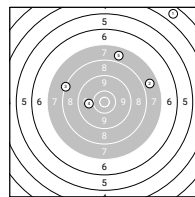
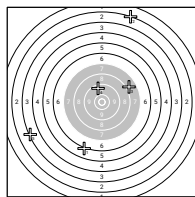
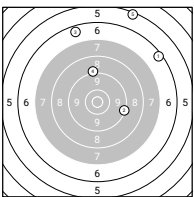

Ergebnis: **327** (344.4)

Wertung: 327 Serien: 45 46 38 45 33 36 38 46

Zähler: 6 16 9 5 1 2 0 0 0 0 1

Innenzehner: 1

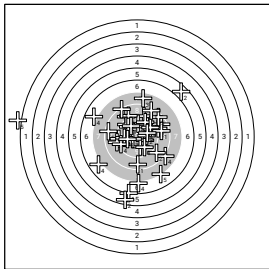

Wertung

Wertung

Serie 1:	10.3 [3.83] ➔	9.1 [5.40] ⬆	9.0 [6.51] ⬆	9.9 [7.90] ⬆	8.5 [8.85] ⬆
Serie 2:	9.4 [3.82] ⬆	10.2 [5.11] ➔	8.7 [6.86] ➔	10.1 [8.24] ⬇	9.8 [9.40] ⬆
Serie 3:	6.2 [4.12] ⬇	9.1 [5.25] ➔	9.6 [6.67] ⬆	7.1 [8.01] ⬇	7.3 [9.07] ⬇
Serie 4:	9.2 [3.65] ⬆	9.6 [4.71] ⬆	10.5* [6.59] ⬆	8.1 [7.68] ➔	9.1 [8.96] ⬆
Serie 5:	8.9 [3.00] ➔	9.6 [4.62] ➔	9.9 [5.49] ⬆	7.0 [6.68] ⬆	0.0 [8.22] ⬆
Serie 6:	8.7 [4.22] ⬇	5.6 [6.18] ⬇	8.3 [7.31] ⬆	7.0 [8.62] ⬆	8.5 [9.52] ⬆
Serie 7:	8.5 [3.91] ⬆	5.7 [5.23] ⬆	7.7 [6.97] ⬆	9.5 [8.15] ⬆	9.8 [9.15] ⬆
Serie 8:	9.9 [3.78] ⬆	8.9 [4.92] ➔	9.9 [6.09] ⬇	10.1 [7.59] ⬆	10.1 [8.84] ➔

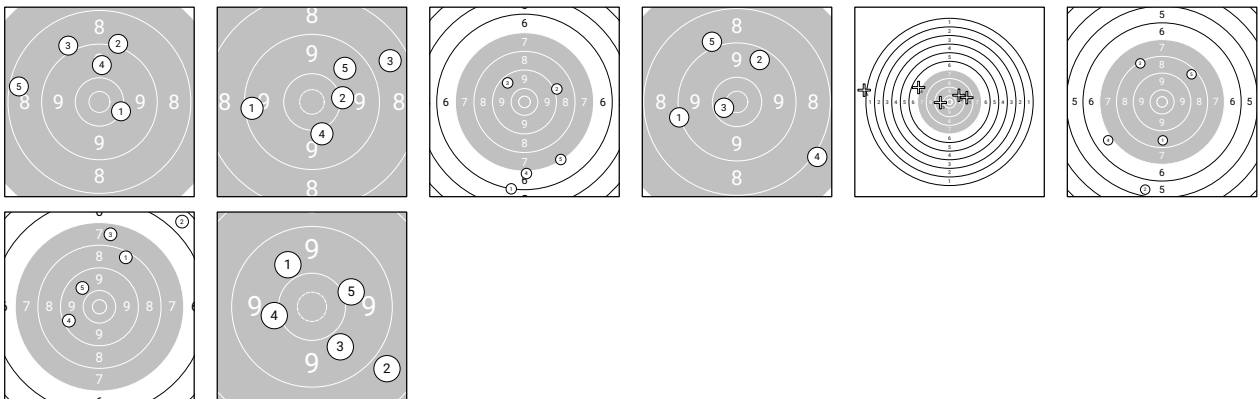

Ergebnis: **341** (355.9)

Wertung: 341 Serien: 41 42 38 43 41 45 47 44

Zähler: 11 11 9 6 3 0 0 0 0 0 0

Innenzehner: 3

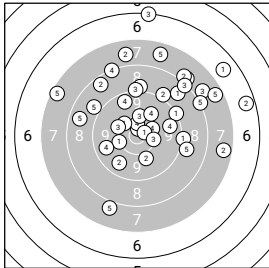

Wertung

Wertung

Serie 1:	9.2 [5.83] →	8.5 [6.46] ↘	7.9 [7.12] ↘	8.3 [7.72] ↘	9.0 [8.26] →
Serie 2:	6.8 [5.34] ↗	9.7 [6.06] ↘	10.7* [6.66] ↑	9.6 [7.28] ↘	8.2 [7.83] ↗
Serie 3:	9.2 [5.16] ↗	6.6 [6.58] →	6.2 [7.23] ↑	10.5* [7.73] ↑	7.7 [8.29] ↑
Serie 4:	8.0 [4.91] ↗	9.1 [5.54] ↗	10.2 [6.19] ↑	9.1 [6.80] ↑	7.5 [7.34] ↘
Serie 5:	8.7 [4.83] ↗	8.0 [5.57] ↗	8.3 [6.28] ↗	10.3 [6.91] →	7.6 [7.53] ↗
Serie 6:	10.3 [5.24] ↘	7.8 [6.57] ↑	10.1 [7.30] ↘	10.0 [7.95] ↗	8.6 [8.65] ↘
Serie 7:	10.2 [4.72] ↖	10.0 [5.39] ↘	9.2 [6.58] ↑	9.6 [7.20] →	9.0 [7.79] ↘
Serie 8:	10.6* [5.34] →	7.6 [6.10] →	10.3 [6.82] →	9.7 [7.48] ↖	8.0 [8.15] ↘

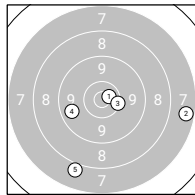
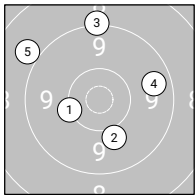
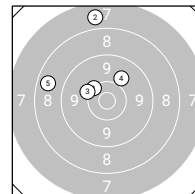
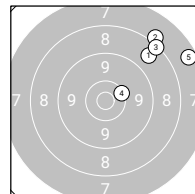
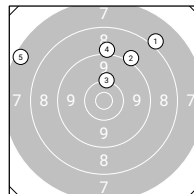
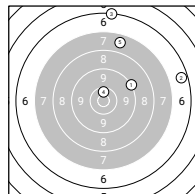
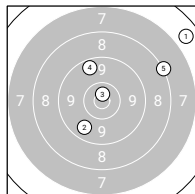
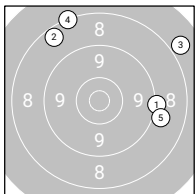

Ergebnis: **354** (370.5)
 Wertung: 354 Serien: 43 44 44 43 42 48 45 45
 Zähler: 11 17 7 5 0 0 0 0 0 0
 Innenzehner: 5

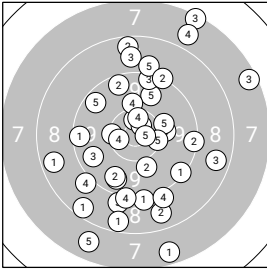

Wertung

Wertung

Serie 1:	7.6 [4.87] ↓	10.0 [5.98] ↓	7.3 [6.95] ↑	10.3 [7.60] ←	9.8 [8.30] ↑
Serie 2:	10.5* [4.86] ↑	9.3 [5.96] →	7.5 [6.89] →	9.0 [7.64] ↙	9.5 [8.41] ↖
Serie 3:	8.6 [5.65] ↙	8.5 [6.72] ↑	8.8 [7.39] ↑	10.1 [8.09] ↑	10.1 [8.92] →
Serie 4:	9.3 [5.54] ↘	9.5 [6.72] ↑	9.4 [7.72] ↑	7.8 [8.43] ↑	9.0 [9.22] ↑
Serie 5:	9.1 [5.36] ↓	8.7 [6.51] ↓	9.0 [7.37] ↓	9.1 [7.90] ↓	7.7 [9.05] ↓
Serie 6:	9.4 [5.06] ←	9.6 [6.07] ↓	10.6* [6.80] ↑	10.5* [7.56] ←	10.1 [8.62] →
Serie 7:	8.5 [5.09] ↙	9.2 [6.35] ↑	9.6 [7.17] ←	9.2 [8.05] ↓	10.3 [8.79] →
Serie 8:	8.5 [5.57] ↓	9.7 [6.60] ↓	8.6 [7.72] →	10.5* [8.33] ↑	10.7* [9.26] →

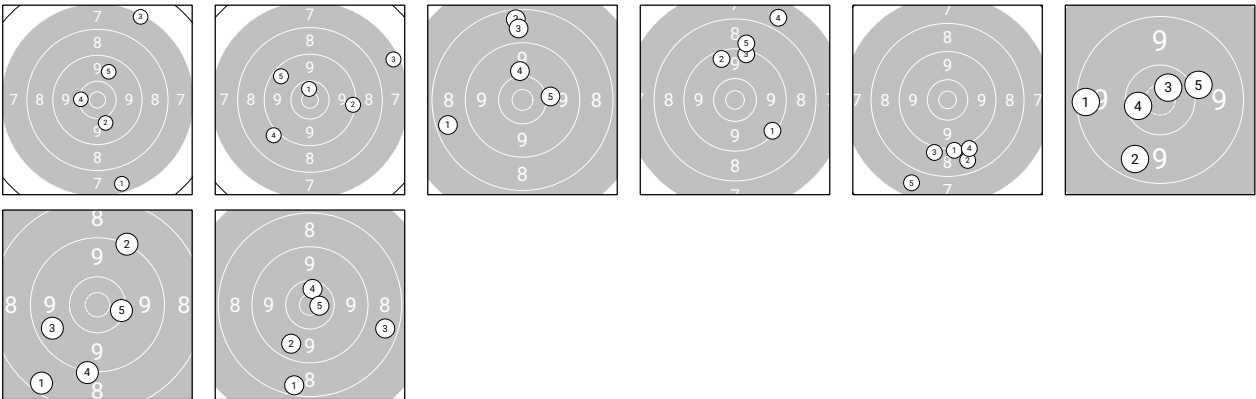

Ergebnis: **200** (211.7)

Wertung: 200 Serien: 26 32 25 33 18 30 9 27

Zähler: 3 3 4 6 5 4 2 2 2 1 1

Innenzehner: 2

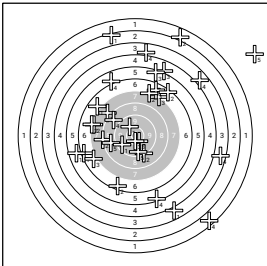

Wertung

Wertung

Serie 1:	2.4 [4.97] ↑	9.3 [6.01] ↓	10.4* [7.71] ↓	5.4 [8.48] ↓	
Serie 2:	6.4 [5.20] ←	6.5 [6.14] ↓	7.2 [7.34] ↑	4.0 [8.26] ↑	9.6 [9.36] ↓
Serie 3:	8.0 [4.98] ←	8.2 [6.04] ←	6.8 [6.68] ↑	3.9 [7.92] ↑	
Serie 4:	10.1 [4.73] ↓	7.2 [6.10] ↑	5.1 [7.33] ↑	3.7 [8.28] →	8.8 [8.79] ←
Serie 5:	4.0 [5.92] ↓	6.4 [7.41] ↑	7.0 [8.43] ←	1.6 [8.97] ↓	0.0 [9.30] →
Serie 6:	5.9 _{NAM} [0.00] ←	7.4 [0.00] ←	10.5* [0.00] ↓	8.7 [0.00] ←	
Serie 7:	7.0 [5.37] ←	2.0 [8.26] ↑			
Serie 8:	9.6 [5.28] ←	7.2 [7.70] ←	5.4 [8.43] ↑	6.0 [8.83] ↑	

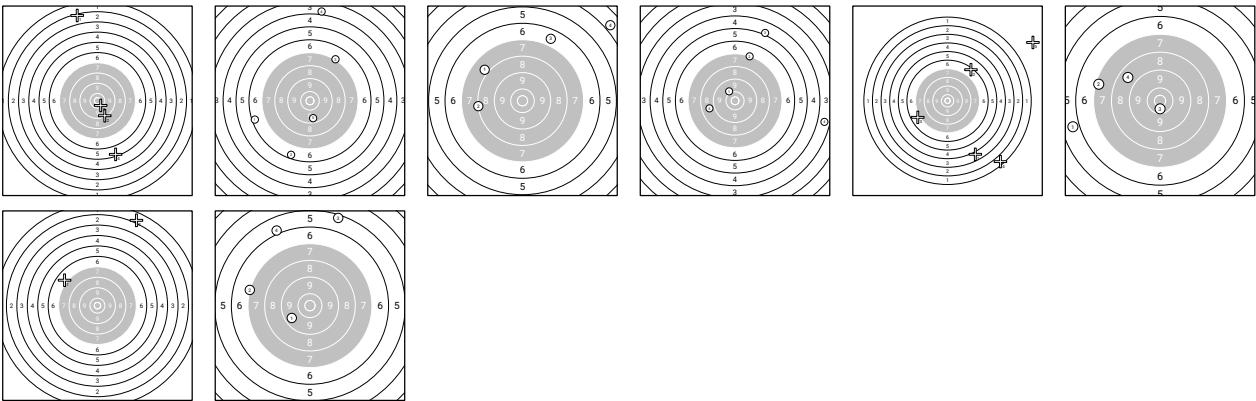

Fußnoten-Legende:

NAM - nicht anerkannte Waffenstörung



Ergebnis: **251** (264.1)

Wertung: 251 Serien: 26 35 33 30 30 30 31 36

Zähler: 2 7 8 8 2 4 1 3 1 1 3

Innenzehner: 0

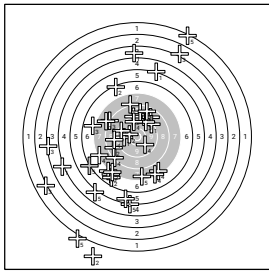

Wertung

Wertung

Serie 1:	3.8 [4.67] ↑	8.9 [6.17] ↗	7.1 [7.02] ↘	8.3 [8.08] ↘	0.0 [8.83] ↘
Serie 2:	9.8 [4.55] ←	10.3 [6.10] ←	2.1 [6.89] ←	7.5 [7.61] ↘	7.1 [8.90] ↘
Serie 3:	8.1 [5.19] ↑	8.7 [6.22] ↘	3.3 [7.04] ←	7.4 [7.81] ↘	7.6 [8.63] ↓
Serie 4:	9.3 [5.34] ↗	6.9 [6.26] ↘	3.0 [7.32] ↗	7.4 [8.11] ↘	5.2 [9.37] ↓
Serie 5:	4.1 [5.77] ←	9.2 [6.86] ↑	9.5 [8.45] ↗	8.8 [9.42] ↑	0.0 ^{AST,OOT} [0.00] ←
Serie 6:	5.2 [0.00] ↑	6.3 [0.00] ↘	8.6 [0.00] ↗	10.0 _{NAM} [0.00] ↘	1.3 _{NAM} [0.00] ↗
Serie 7:	9.5 [5.88] ←	0.0 [6.78] ↘	8.2 [7.69] ←	9.6 [8.84] ↑	5.6 [9.59] ↓
Serie 8:	8.0 [5.26] ←	7.3 [6.18] ↘	7.1 [7.25] ←	9.0 [8.44] ←	5.0 [9.08] ↘

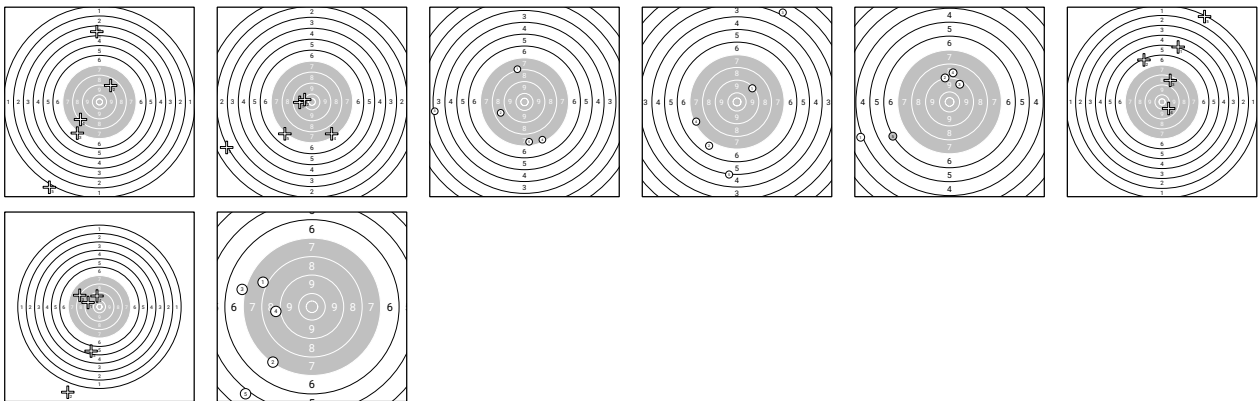

Fußnoten-Legende:

- NAM** - nicht anerkannte Waffenstörung
- AST** - Treffer wurde nach Ende der Schießzeit abgegeben
- OOT** - Treffer wurde außerhalb der Schießzeit abgegeben



Ergebnis: **328** (345.4)

Wertung: 328 Serien: 40 44 43 40 45 42 40 34

Zähler: 9 7 11 10 2 1 0 0 0 0 0

Innenzehner: 5

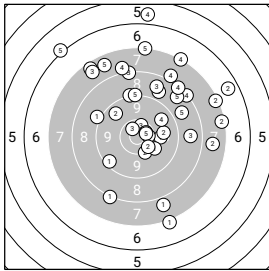

Wertung

Wertung

Serie 1:	10.0 [3.21] →	6.7 [5.02] ↘	10.4* [6.45] ↗	7.5 [7.82] ↖	7.2 [8.79] ↑
Serie 2:	10.5* [3.28] ↗	9.6 [4.87] ↖	8.3 [6.10] ↑	8.0 [7.15] ↑	9.2 [8.19] ↑
Serie 3:	7.1 [3.77] ↘	9.8 [5.88] →	10.5* [7.04] →	9.7 [8.19] ↗	8.8 [9.46] ↗
Serie 4:	8.2 [3.46] ↘	7.4 [5.00] →	8.9 [6.35] ↗	8.3 [7.72] ↗	9.2 [8.77] ↑
Serie 5:	9.1 [3.35] ↖	10.2 [5.34] ↘	10.6* [7.12] ↖	8.0 [8.31] ↗	8.6 [9.44] ↗
Serie 6:	9.4 [3.40] ↖	7.8 [5.19] →	8.7 [6.62] →	8.3 [7.70] ↗	10.6* [8.72] →
Serie 7:	10.1 [4.03] ↘	10.3 [5.79] ↘	8.7 [7.03] ↗	5.8 [8.36] ↑	7.7 [9.55] ↖
Serie 8:	7.9 [3.65] ↘	7.3 [5.46] ↗	7.7 [7.17] ↖	7.2 [8.40] ↗	6.1 [9.53] ↖

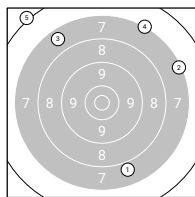
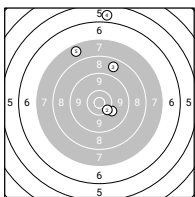
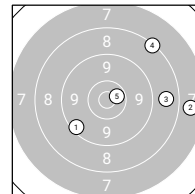
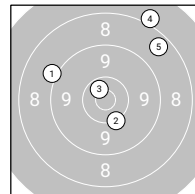
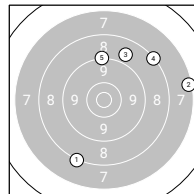
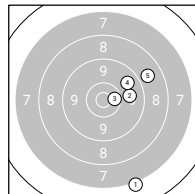
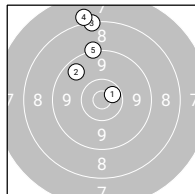
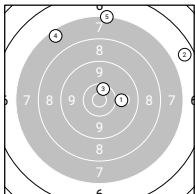

Ergebnis: **305** (323.2)

Wertung: 305 Serien: 35 37 41 40 42 32 38 40

Zähler: 6 7 8 11 4 2 1 1 0 0 0

Innenzehner: 2

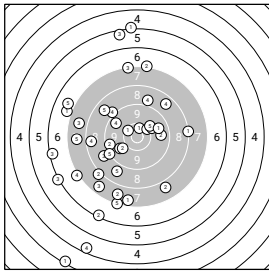

Wertung

Wertung

Serie 1:	5.2 [3.84] ↑	6.3 [5.25] ↓	8.9 [6.46] ←	9.6 [7.19] ↖	7.3 [8.10] ↓
Serie 2:	10.4* [4.52] ↖	9.7 [5.59] →	7.3 [6.65] ↑	4.5 [7.61] ↓	7.7 [8.12] ←
Serie 3:	8.2 [3.69] →	9.4 [4.78] ←	6.4 [6.13] ←	9.1 [7.09] ↖	9.9 [7.89] ←
Serie 4:	7.6 [3.92] ↓	10.0 [5.17] ←	6.2 [6.47] ←	8.5 [7.27] ←	9.2 [8.07] ←
Serie 5:	10.5* [4.34] ↑	7.2 [5.42] ↑	7.6 [6.47] ↓	10.3 [7.15] ↗	8.8 [8.28] ↓
Serie 6:	7.0 [3.44] ↖	7.7 [4.46] ↓	5.5 [5.47] ↑	7.2 [6.09] ←	6.9 [6.84] ↖
Serie 7:	3.3 [4.58] ↓	7.9 [5.75] ↓	10.0 [6.84] ↗	8.6 [7.83] ↗	10.1 [8.82] ↗
Serie 8:	9.7 [5.10] →	8.1 [6.56] ←	7.8 [7.55] ←	8.9 [8.23] ↑	8.7 [9.00] ↖

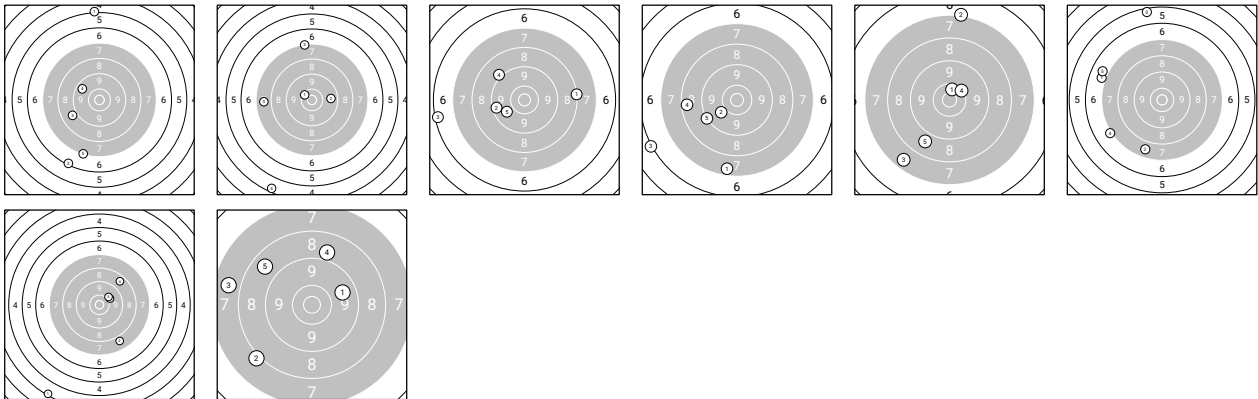

Ergebnis: **239** (258.2)

Wertung: 239 Serien: 33 38 31 25 27 27 31 27

Zähler: 0 3 8 7 5 8 4 3 2 0 0

Innenzehner: 0

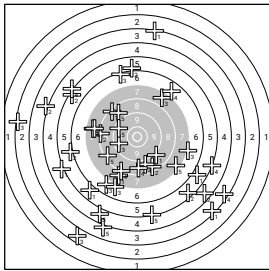

Wertung

Wertung

Serie 1:	8.4 [4.75] ↙	8.3 [5.68] ←	6.9 [6.45] ↘	3.5 [7.24] ➤	8.8 [7.94] ↗
Serie 2:	7.9 [4.72] ↘	8.6 [5.87] ↘	7.2 [6.97] ➤	8.9 [7.94] ↘	8.5 [8.50] ↙
Serie 3:	5.9 [5.13] ↗	4.7 [5.74] ➤	9.6 [6.34] ←	8.3 [7.02] ↘	5.3 [7.64] ↓
Serie 4:	5.9 [4.50] ➤	6.1 [5.14] ←	2.7 [6.06] ↘	5.2 [6.91] ➤	7.5 [7.42] ➤
Serie 5:	3.4 [4.49] ➤	5.6 [5.28] ➤	7.0 [5.87] ↘	8.7 [6.67] ↓	4.0 [7.35] ↓
Serie 6:	5.1 [0.00] ↙	5.4 [0.00] ↙	6.3 [0.00] ↗	7.7 _{NAM} [0.00] ←	4.8 _{NAM} [0.00] ↘
Serie 7:	3.3 [4.55] ↑	6.0 [5.25] ↑	7.7 [6.10] ↗	6.9 [6.84] ↗	9.5 [7.55] ↙
Serie 8:	9.1 [4.54] ➤	4.1 [5.25] ←	2.4 [5.98] ←	5.2 [6.92] ↙	7.8 [7.56] ←

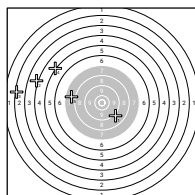
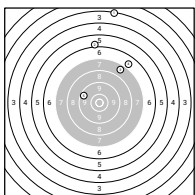
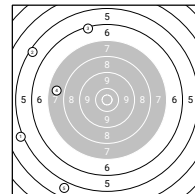
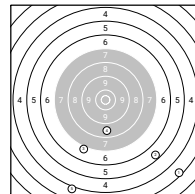
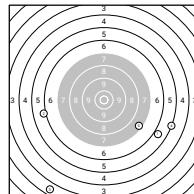
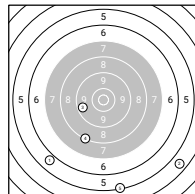
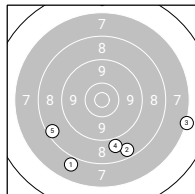
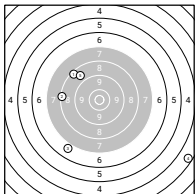

Fußnoten-Legende:

NAM - nicht anerkannte Waffenstörung



Ergebnis: **306** (325.6)

Wertung: 306 Serien: 44 34 40 38 38 42 37 33

Zähler: 4 9 10 11 2 3 0 0 0 1 0

Innenzehner: 2

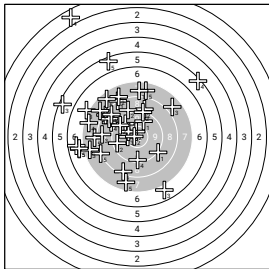

Wertung

Wertung

Serie 1:	9.8 [3.43] ↗	10.6* [4.38] ↑	10.3 [5.55] ←	8.9 [6.60] ↖	7.8 [7.69] ↑
Serie 2:	8.2 [4.14] ↖	9.0 [5.25] ↑	5.5 [6.50] ↖	5.4 [7.75] ↗	7.0 [9.17] ←
Serie 3:	8.4 [3.96] ↖	9.5 [5.27] ←	7.1 [6.50] ↖	8.7 [7.52] ↖	8.1 [8.59] ←
Serie 4:	7.8 [3.35] ↑	8.0 [4.55] ↖	9.8 [5.63] ↖	9.4 [6.74] ↓	5.5 [7.84] ↖
Serie 5:	9.2 [4.54] ↘	9.0 [5.46] ↑	6.9 [6.42] ↓	7.9 [7.33] ↖	7.7 [8.38] ↖
Serie 6:	10.3 [3.75] ↖	9.6 [4.97] ↖	7.8 [6.21] ↗	8.4 [7.46] ↓	8.2 [8.56] ↖
Serie 7:	6.8 [4.08] ←	10.8* [5.09] ←	7.6 [6.08] ←	7.6 [7.33] ←	7.0 [8.47] ←
Serie 8:	8.7 [4.17] ↖	9.2 [5.26] ↑	8.6 [6.15] ←	1.7 [8.17] ↖	7.8 [9.52] ↓

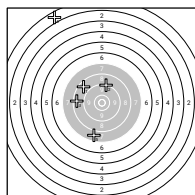
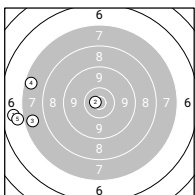
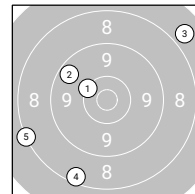
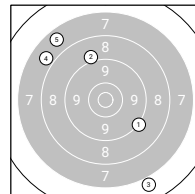
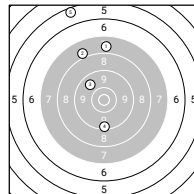
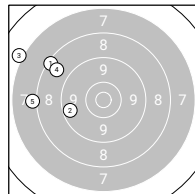
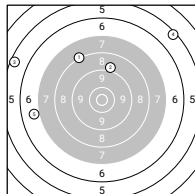
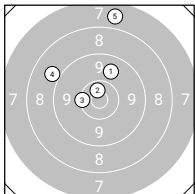

Ergebnis: **290** (307.0)

Wertung: 290 Serien: 34 40 39 36 38 36 34 33

Zähler: 3 6 12 9 4 2 2 1 1 0 0

Innenzehner: 0

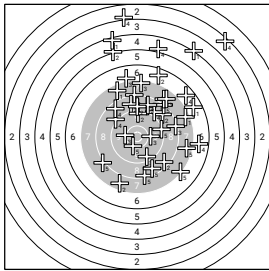

Wertung

Wertung

Serie 1:	7.6 [3.40] ↗	8.5 [3.90] ↘	7.0 [4.68] ↑	2.4 [5.44] ↗	10.3 [6.03] ↘
Serie 2:	8.8 [4.21] ↗	8.7 [5.02] ↗	8.3 [6.08] →	9.0 [6.58] ↗	7.3 [7.17] ↘
Serie 3:	7.5 [3.84] →	5.1 [4.91] ↗	10.1 [5.67] ←	9.1 [6.38] ↗	8.4 [7.05] ↘
Serie 4:	8.2 [4.79] ↑	8.8 [5.40] ↑	9.5 [6.03] ↘	3.1 [6.99] ↑	8.2 [7.51] ↗
Serie 5:	6.8 [4.07] →	7.7 [4.60] ↘	10.1 [5.26] →	8.6 [5.94] ↗	7.6 [6.88] →
Serie 6:	4.2 [3.36] ↗	9.4 [4.21] ↑	8.7 [4.85] ↗	6.9 [5.37] →	9.3 [5.96] →
Serie 7:	7.9 _{NAM} [0.00] ↗	6.7 [0.20] ↗	7.8 [0.69] ↗	6.8 [1.23] ↗	8.7 [1.77] ↘
Serie 8:	4.4 [3.71] ↑	9.0 [4.19] ↑	7.4 [4.66] ↑	5.0 [5.13] ↗	8.1 [5.61] ↗

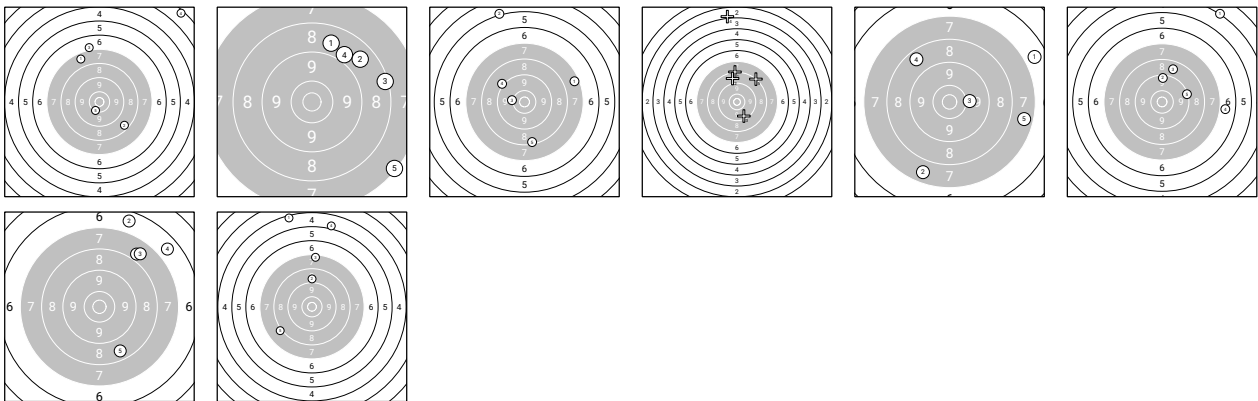

Fußnoten-Legende:

NAM - nicht anerkannte Waffenstörung



Ergebnis: **331** (347.6)

Wertung: 331 Serien: 43 35 40 43 45 40 42 43

Zähler: 4 18 8 6 3 1 0 0 0 0 0

Innenzehner: 0

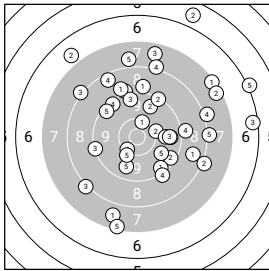

Wertung

Wertung

Serie 1:	10.3 [4.21] ↗	9.4 [5.20] ↘	9.7 [6.20] →	8.1 [7.54] →	7.9 [8.44] ↑
Serie 2:	7.8 [3.93] ↓	6.9 [4.80] ↖	7.7 [6.32] ↑	9.1 [7.60] ↑	6.2 [8.31] →
Serie 3:	8.7 [3.98] →	5.8 [5.38] ↗	9.5 [6.59] ↑	9.4 [7.72] ↖	9.4 [8.80] ↖
Serie 4:	9.4 [3.63] ↘	9.7 [4.92] ↗	6.4 [6.15] →	10.3 [7.52] ↓	9.7 [8.57] ↓
Serie 5:	9.0 [3.71] ↑	10.2 [5.02] →	8.2 [6.37] ↖	9.1 [7.40] →	9.8 [8.46] ↘
Serie 6:	7.4 [4.49] ↗	9.3 [5.42] ↗	8.2 [6.73] ↖	8.1 [7.86] ↑	8.2 [8.94] →
Serie 7:	9.0 [4.52] ↖	8.2 [5.60] ↘	9.3 [7.27] ←	9.2 [8.25] ↘	7.4 [9.05] ↓
Serie 8:	9.9 [4.56] →	7.4 [5.72] ↗	9.7 [7.25] →	8.5 [8.73] ↖	10.1 [9.71] ↓

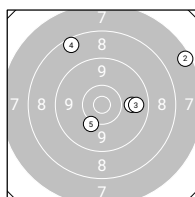
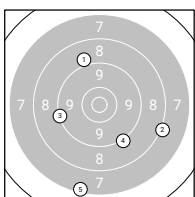
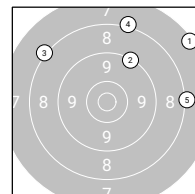
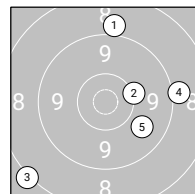
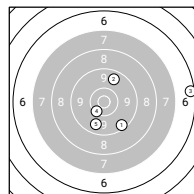
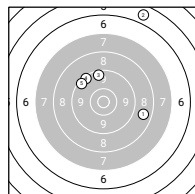
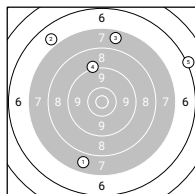
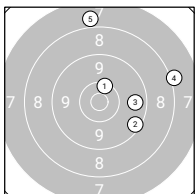

Ergebnis: **346** (363.5)

Wertung: 346 Serien: 45 40 43 44 43 44 42 45

Zähler: 10 13 11 5 1 0 0 0 0 0 0

Innenzehner: 4

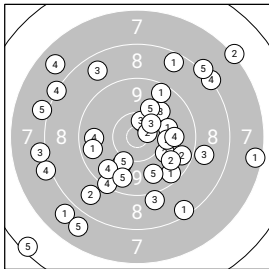

Wertung

Wertung

Serie 1:	7.9 [4.71] ↙	10.0 [5.74] ➤	10.0 [6.77] ↙	8.2 [7.81] ↖	10.1 [8.69] ↘
Serie 2:	7.4 [4.38] ➔	10.5* [5.21] ↗	8.9 [6.25] ➔	9.7 [7.18] ↖	6.4 [7.97] ↙
Serie 3:	9.6 [4.08] ↖	9.5 [5.09] ➔	9.9 [6.80] ↗	8.1 [7.49] ↖	8.0 [8.40] ↖
Serie 4:	9.5 [4.39] ↘	8.8 [5.54] ↙	9.0 [6.50] ↘	9.3 [7.78] ↙	9.8 [8.88] ↘
Serie 5:	8.4 [4.65] ↘	9.7 [5.58] ➔	10.5* [6.54] ↗	9.7 [7.54] ↙	7.8 [8.34] ↙
Serie 6:	10.0 [4.22] ➔	10.6* [5.62] ➔	8.7 [6.54] ↖	7.7 [7.64] ↖	9.7 [8.68] ↘
Serie 7:	9.5 [4.51] ↗	7.2 [5.67] ↗	8.1 [6.60] ↖	8.2 [7.59] ↗	10.0 [8.67] ↗
Serie 8:	8.5 [4.70] ↗	10.1 [5.73] ➔	10.4* [6.66] ↗	9.9 [7.58] ➔	8.2 [8.57] ↗

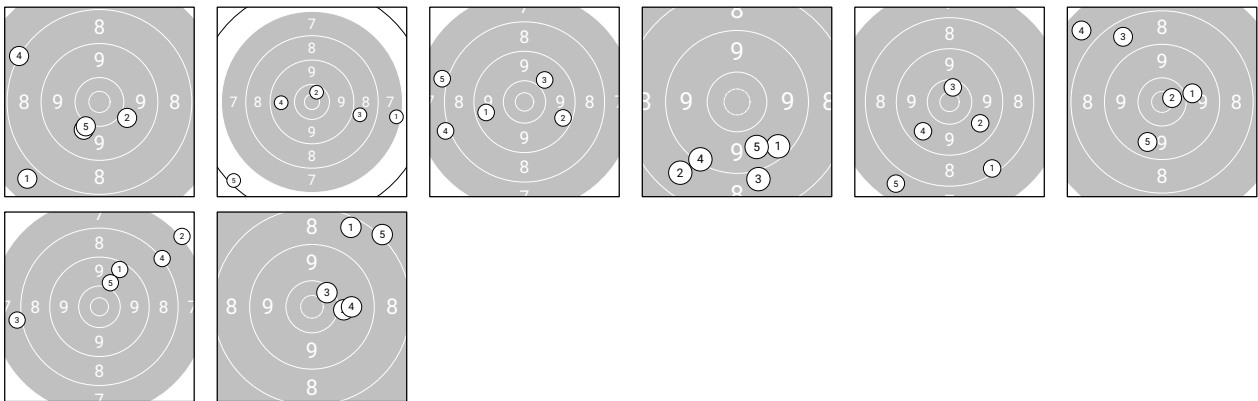

Ergebnis: **348** (367.5)

Wertung: 348 Serien: 42 43 42 43 45 41 46 46

Zähler: 7 19 9 5 0 0 0 0 0 0 0

Innenzehner: 5

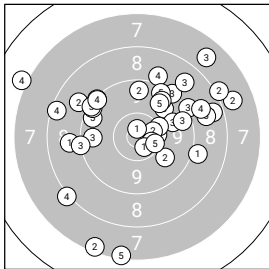

Wertung

Wertung

Serie 1:	8.9 [6.16] ←	7.4 [7.04] ↓	9.2 [7.85] →	9.0 [8.58] ↑	9.8 [9.29] ↗
Serie 2:	9.3 [5.08] ↖	9.9 [5.88] ↘	9.8 [6.67] →	7.1 [7.45] ↙	9.5 [8.34] ↖
Serie 3:	8.5 [5.47] →	8.9 [6.41] ↖	9.3 [7.22] ↗	9.4 [7.94] ↖	8.8 [8.55] →
Serie 4:	10.3 [5.02] →	7.9 [6.05] →	9.5 [6.94] →	8.9 [7.72] →	9.4 [8.43] ↗
Serie 5:	10.2 [4.32] →	10.4* [5.09] →	7.8 [5.79] ↗	9.6 [6.48] ↗	9.3 [7.24] ↖
Serie 6:	9.0 [4.71] →	8.1 [5.65] →	9.6 [6.49] ←	8.4 [7.31] ↖	7.3 [8.14] ↓
Serie 7:	10.7* [5.20] ↑	10.5* [6.06] →	9.2 [7.01] ←	8.2 [7.88] ↖	9.7 [8.60] ↗
Serie 8:	10.6* [5.78] ↘	9.6 [6.97] ↑	8.8 [7.90] ↗	9.3 [8.66] ↖	10.4* [9.44] →

